

Engine Control

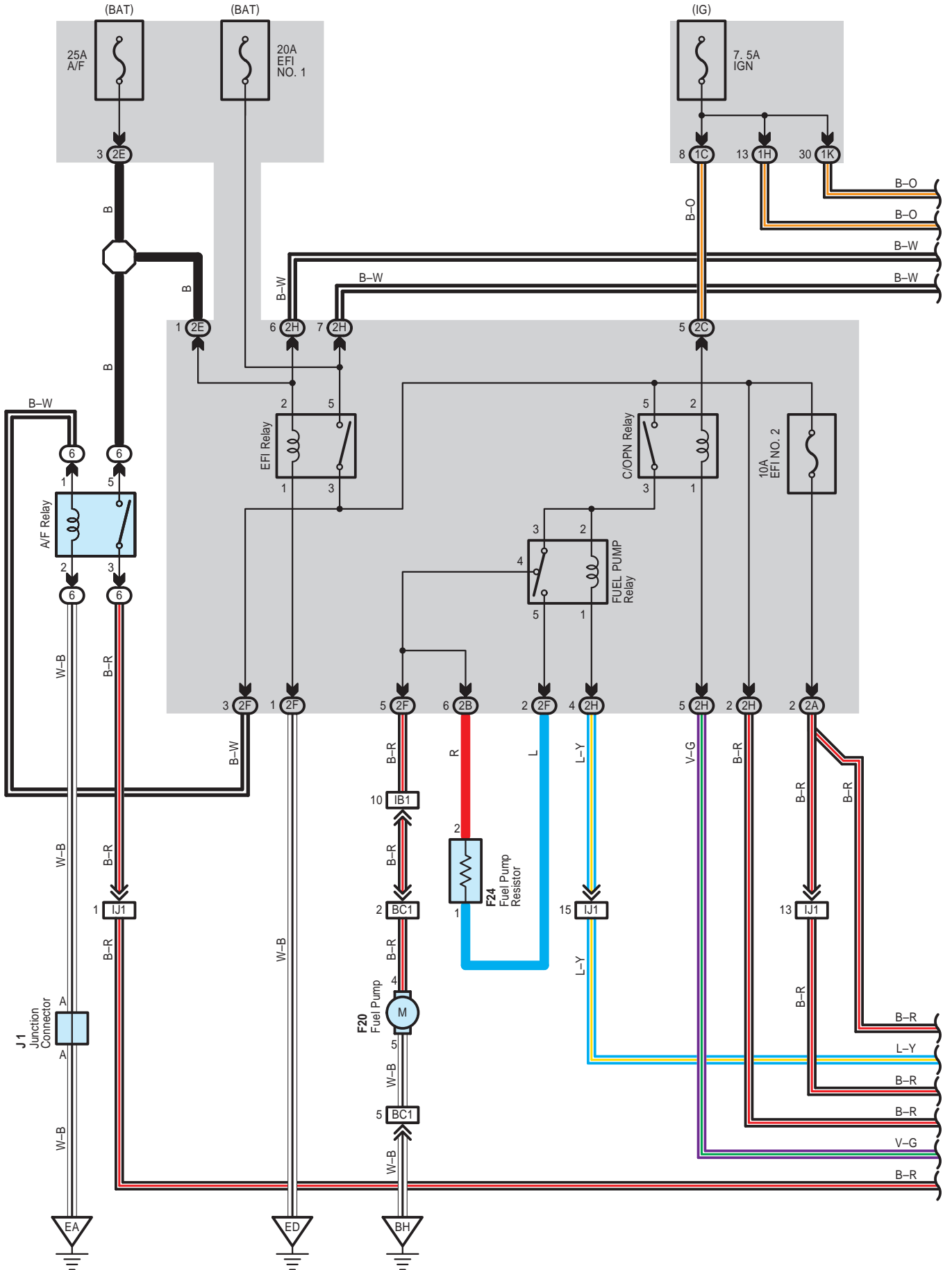

Engine Control

- * 1 : Automatic A/C
- * 2 : Manual A/C

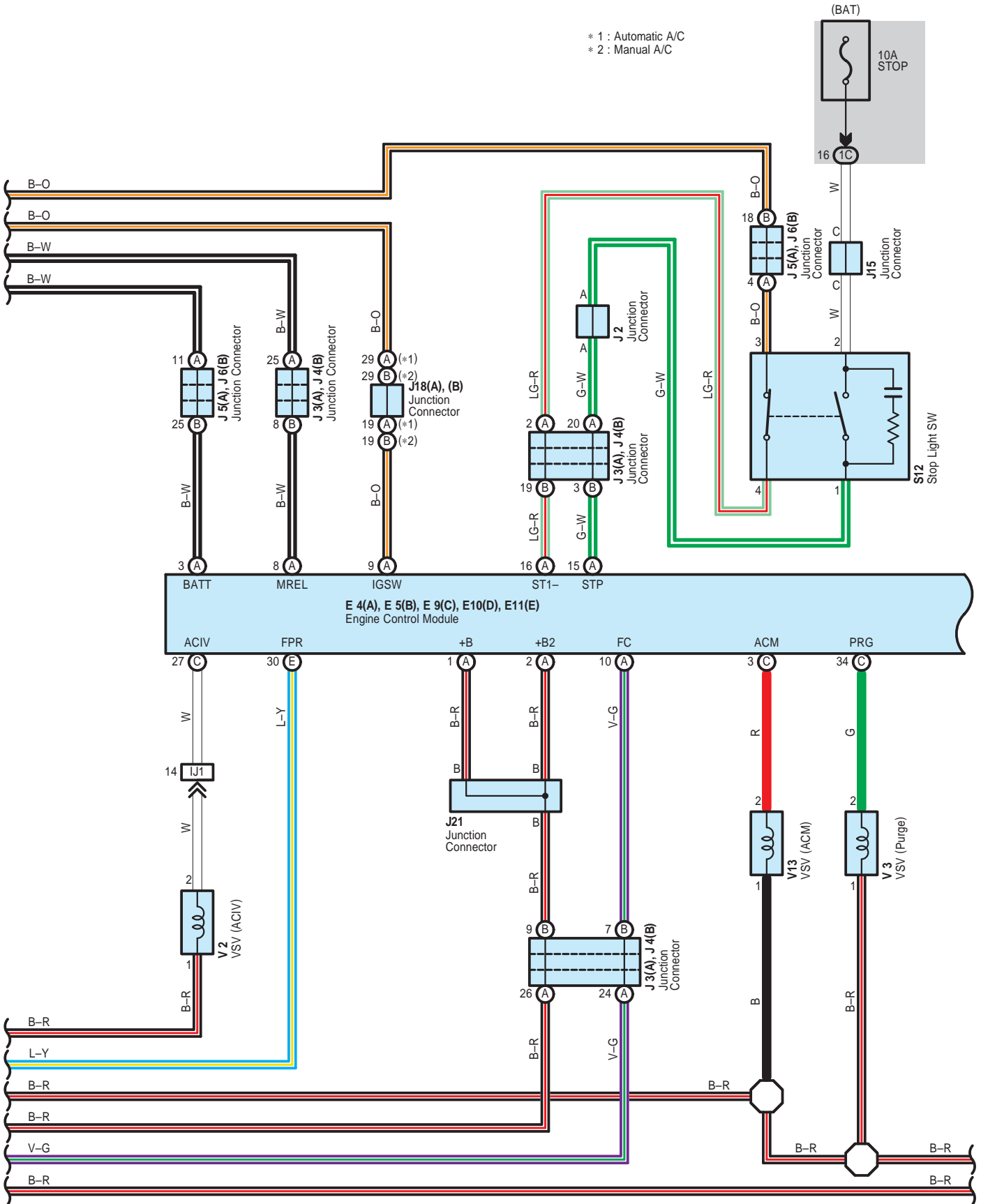

Engine Control

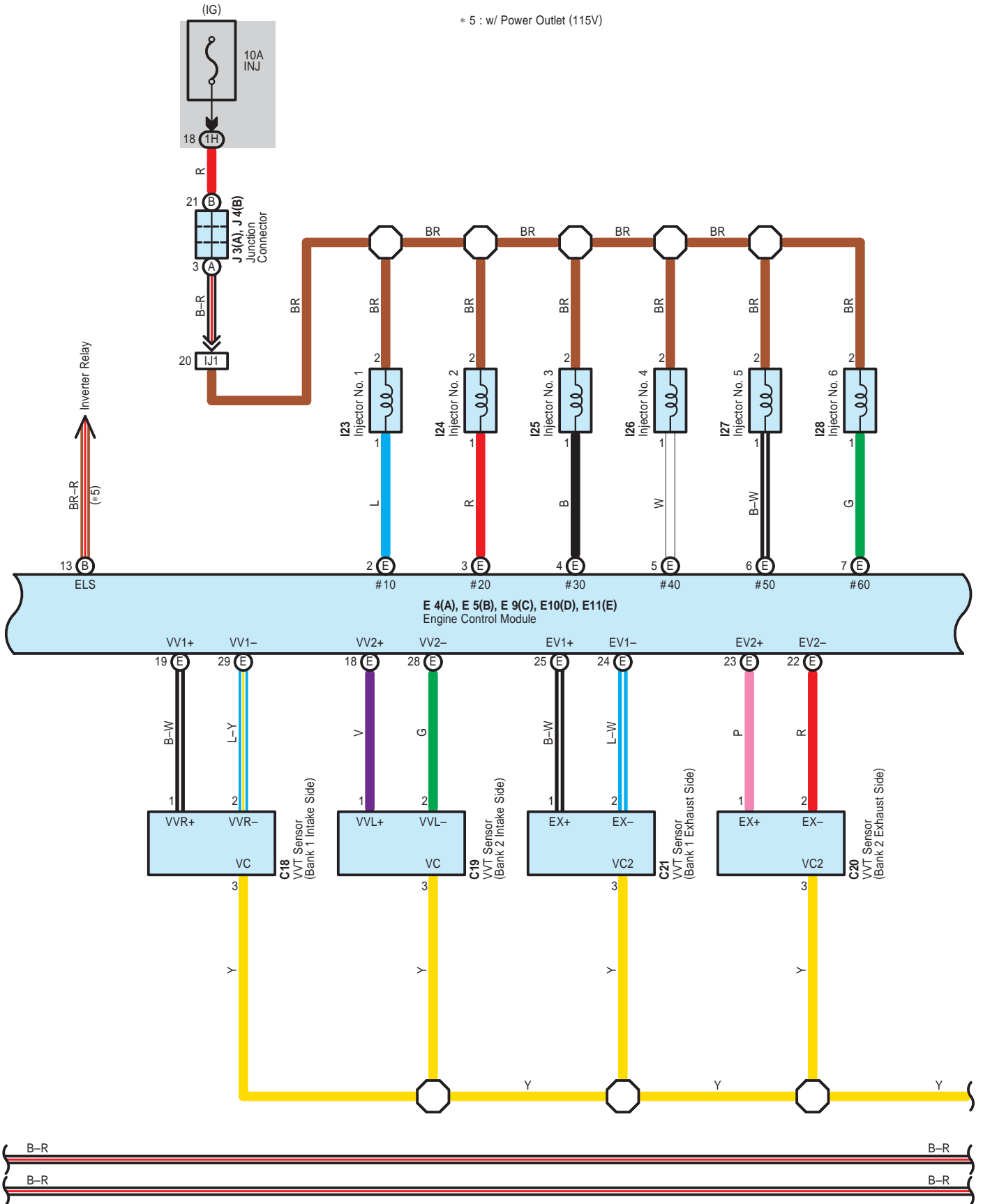

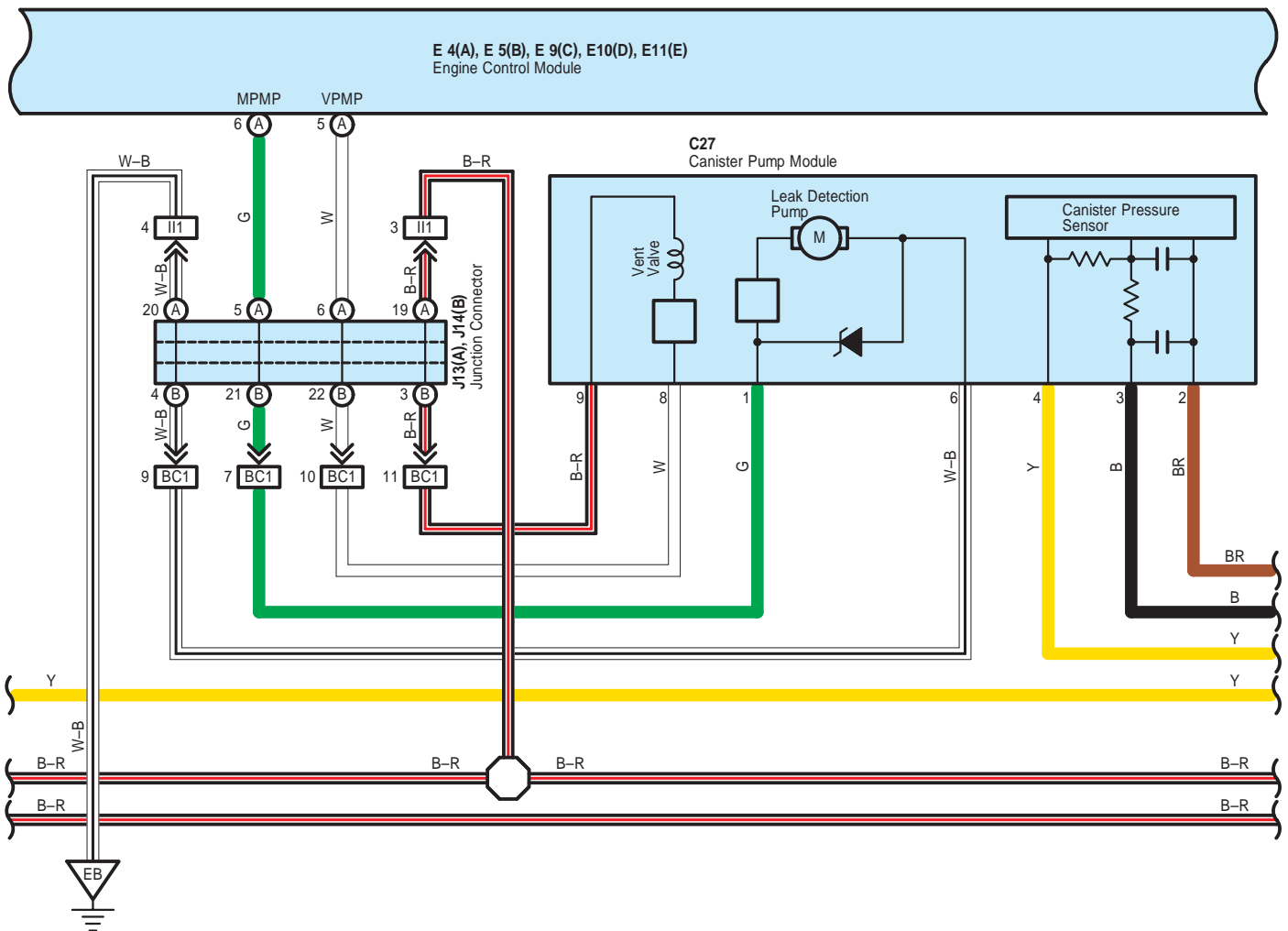

Engine Control

* 1 : Automatic A/C
* 2 : Manual A/C

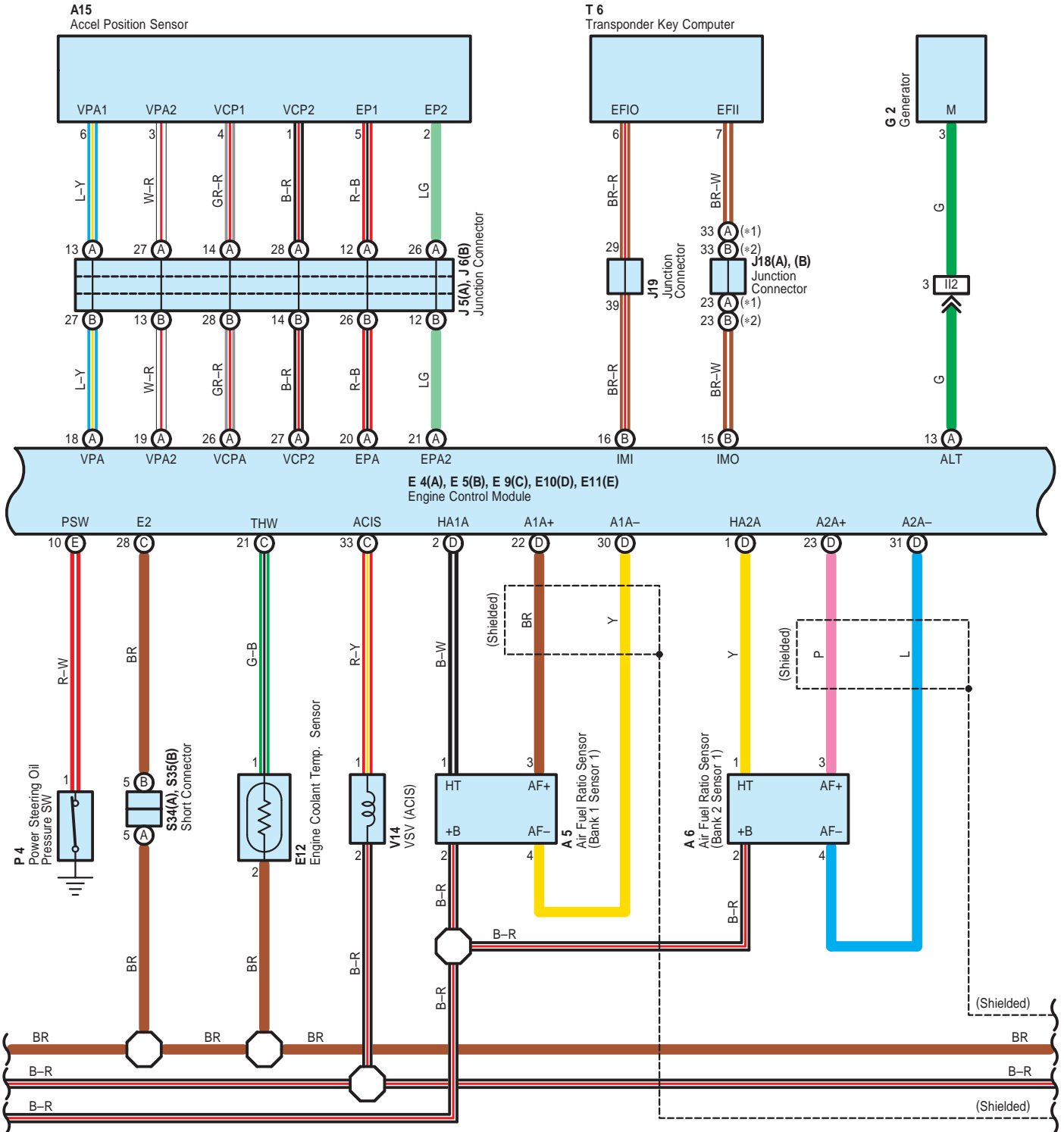

Engine Control

- * 1 : Automatic A/C
- * 2 : Manual A/C
- * 3 : w/ VSC
- * 4 : w/o VSC

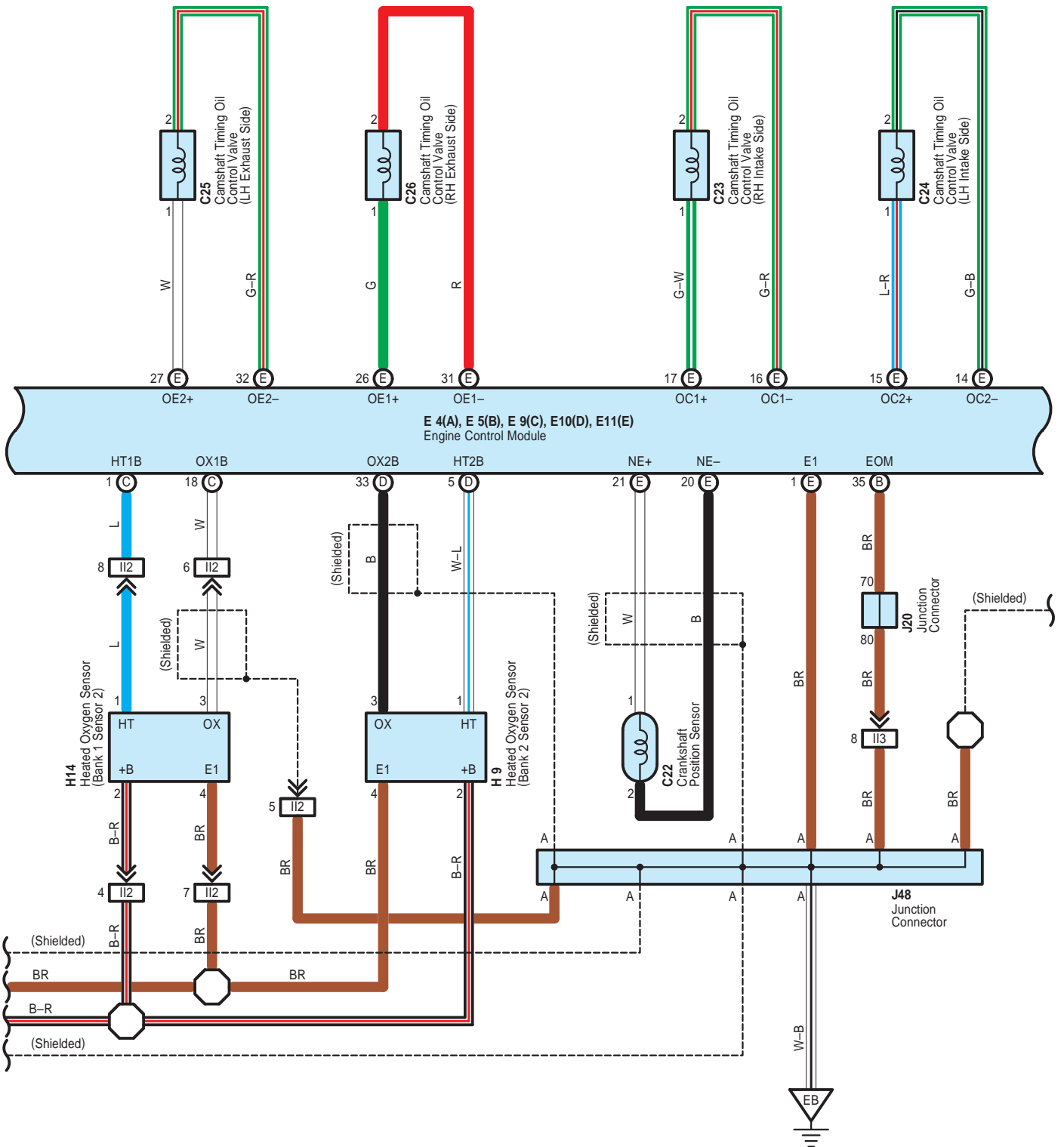

Engine Control

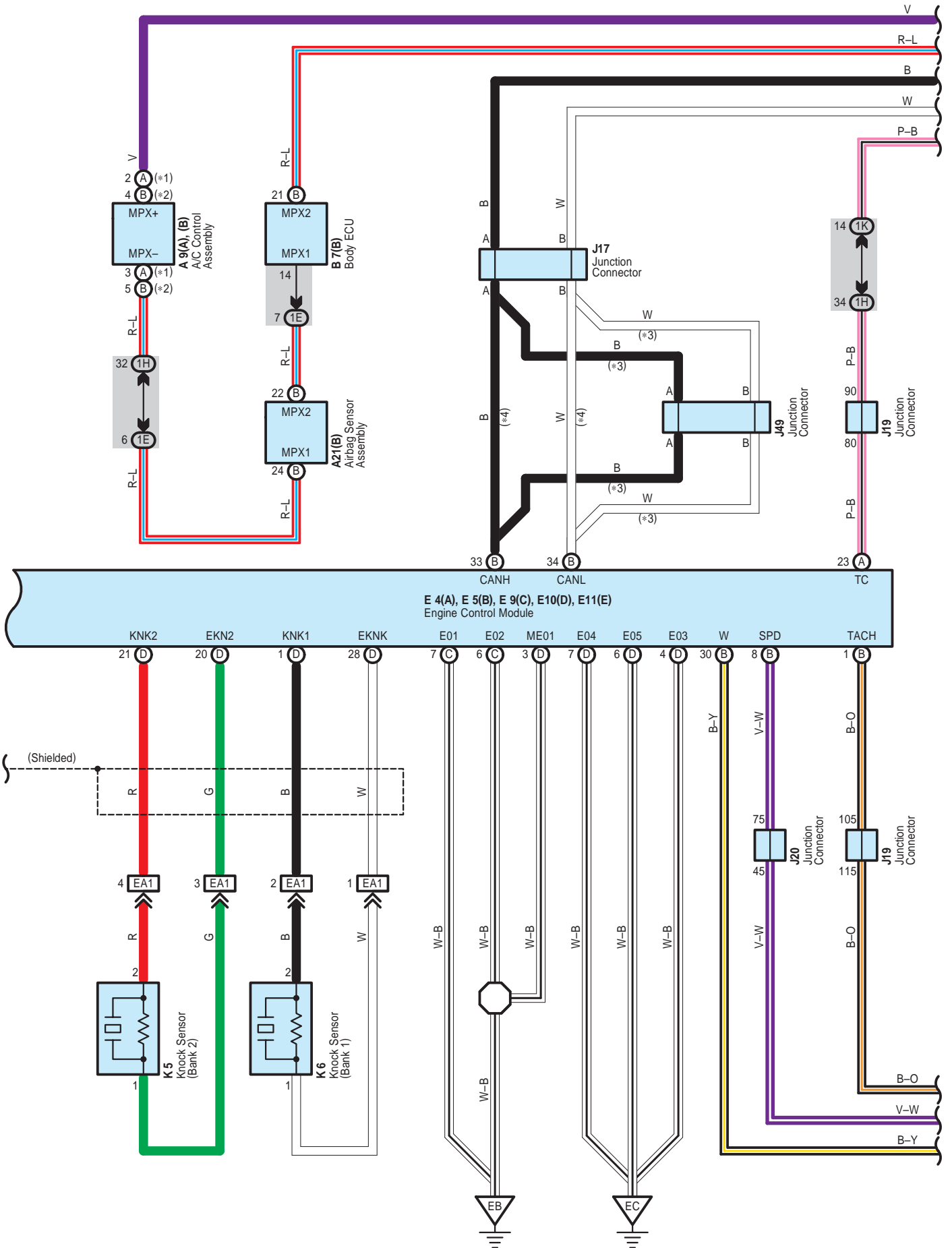

Engine Control

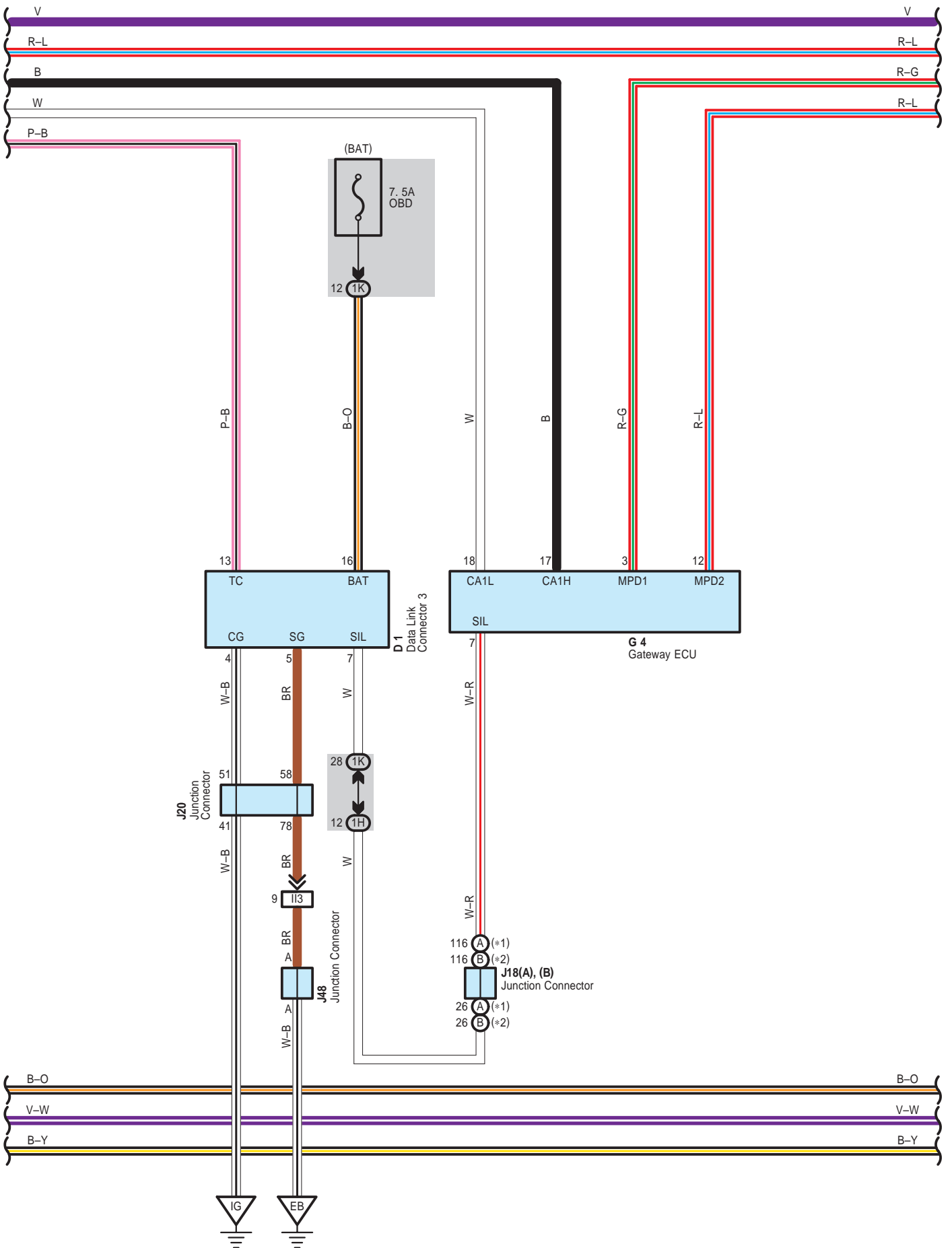

Engine Control

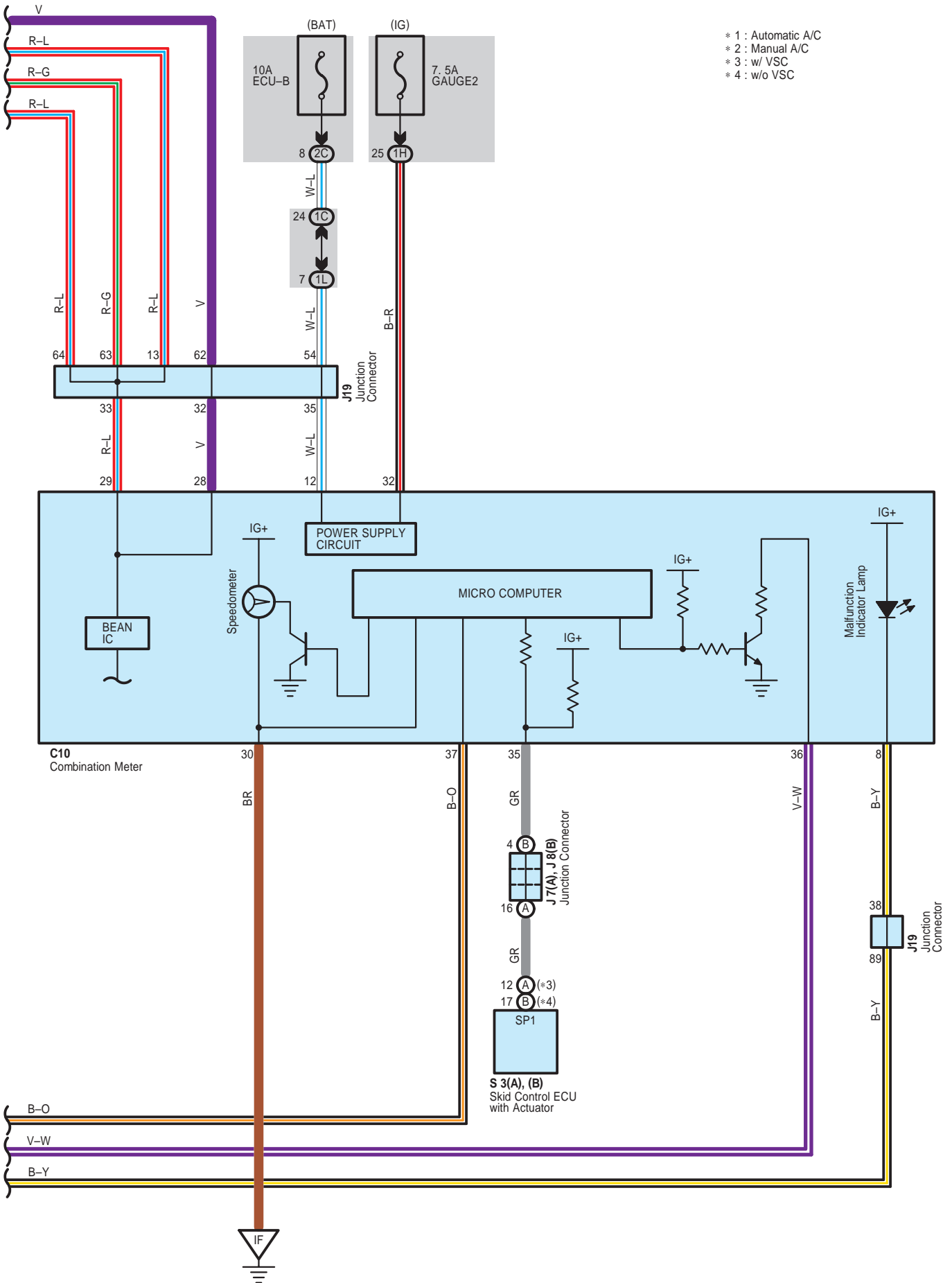

Engine Control

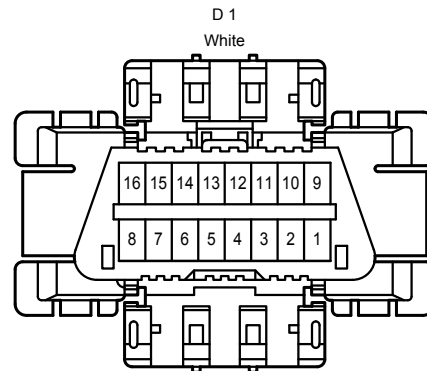
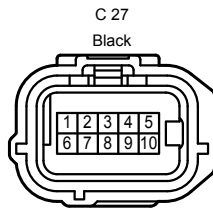
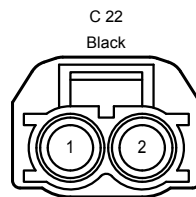
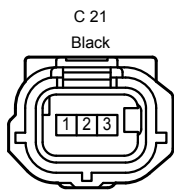
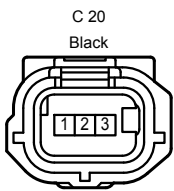
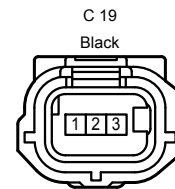
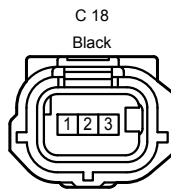
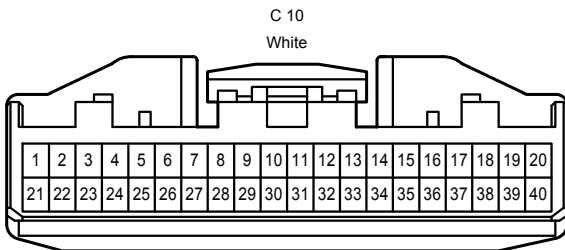
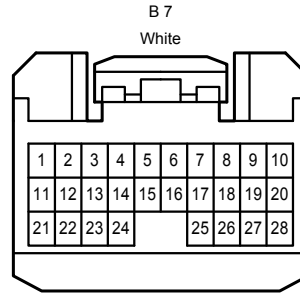
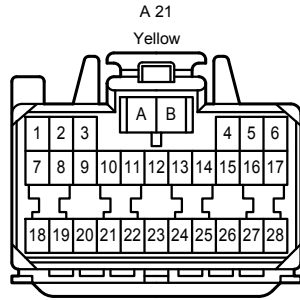
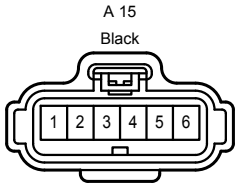
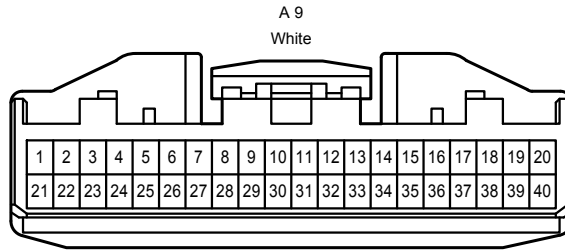

Engine Control

D 16

Black



E 4

White

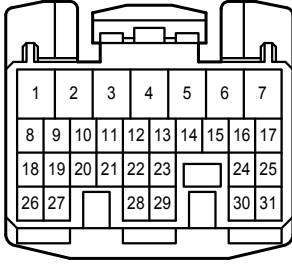

E 5

White

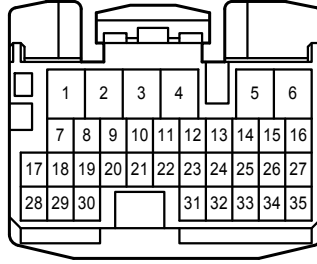

E 9

White

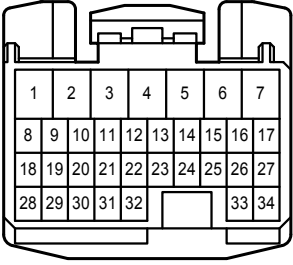

E 10

White

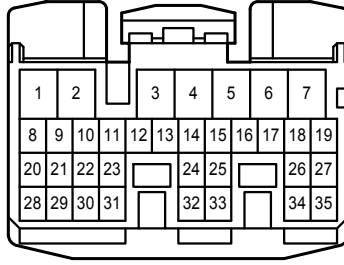

E 11

White

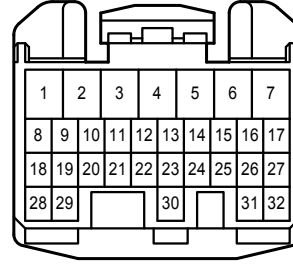

E 12

Gray



F 16

White

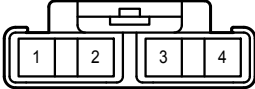

F 20

White



F 24

Black

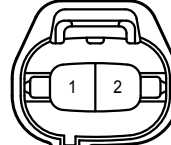

G 2

Black



G 4

White

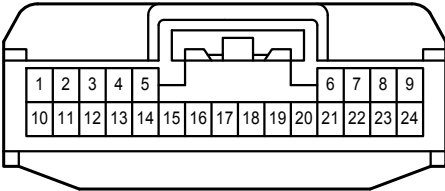

H 9

Gray



H 14

Gray

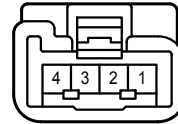

I 23

Gray

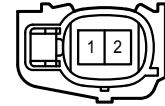

I 24

Gray

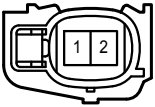

I 25

Gray

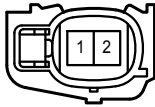

I 26

Gray

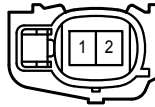

I 27

Gray

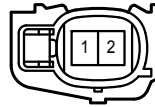

I 28

Gray

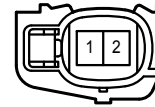

J 1

Blue



J 2

White

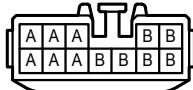

J 3

White

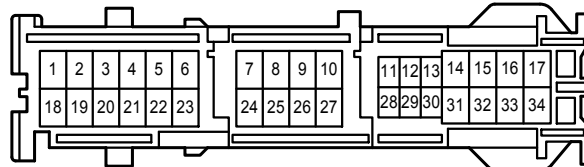

Engine Control

J 4
White

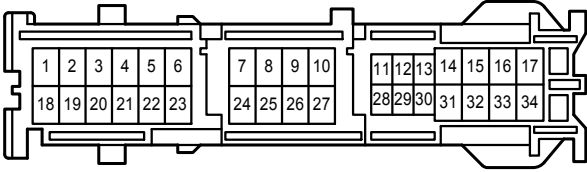

J 5
White

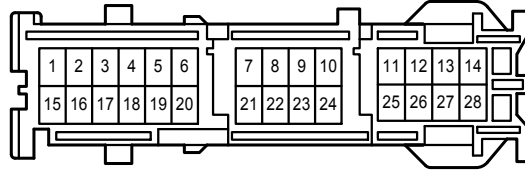

J 6
White

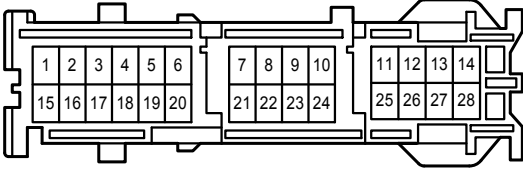

J 7
White

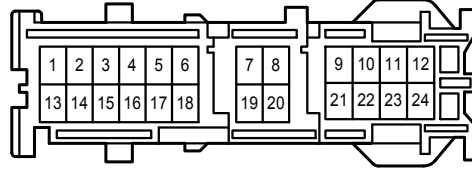

J 8
White

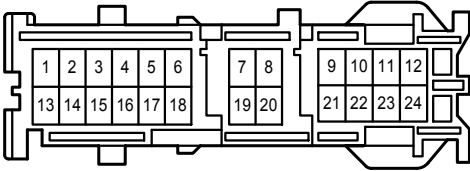

J 13
White

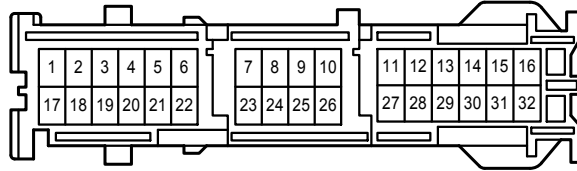

J 14
White

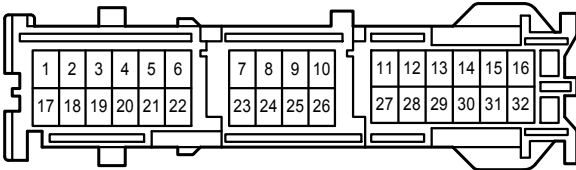

J 15
Gray

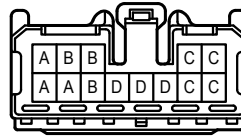

J 17
White

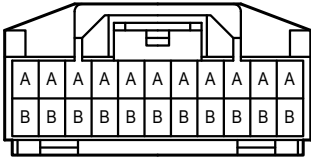

Engine Control

J 18
White

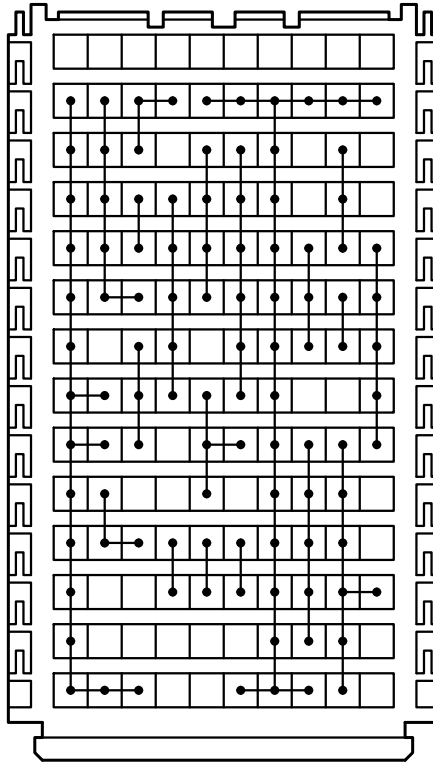
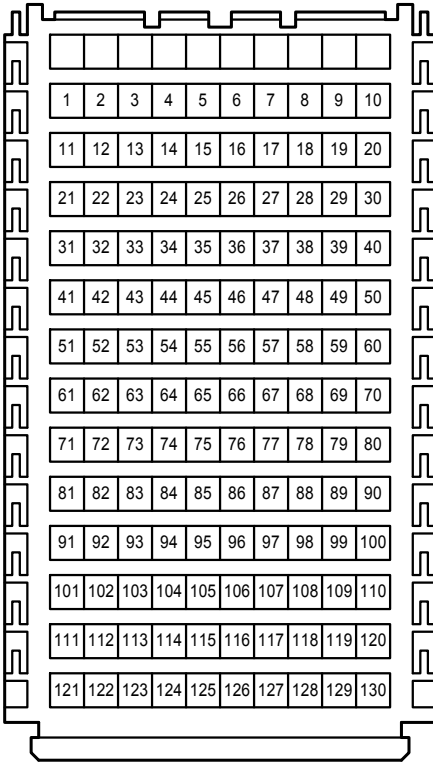

(Automatic A/C)

J 18
White

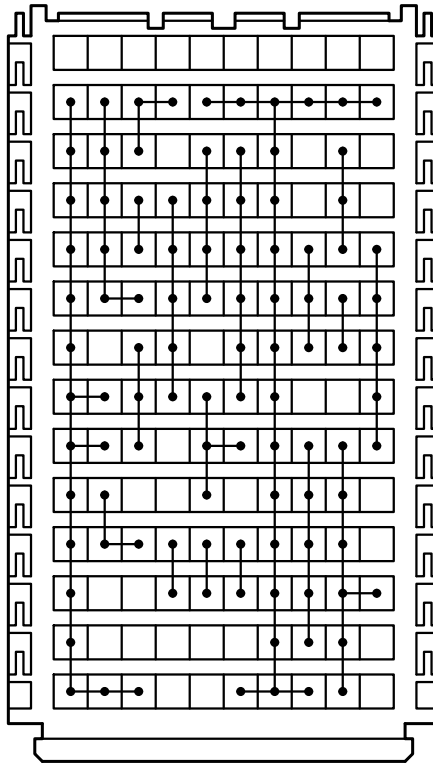
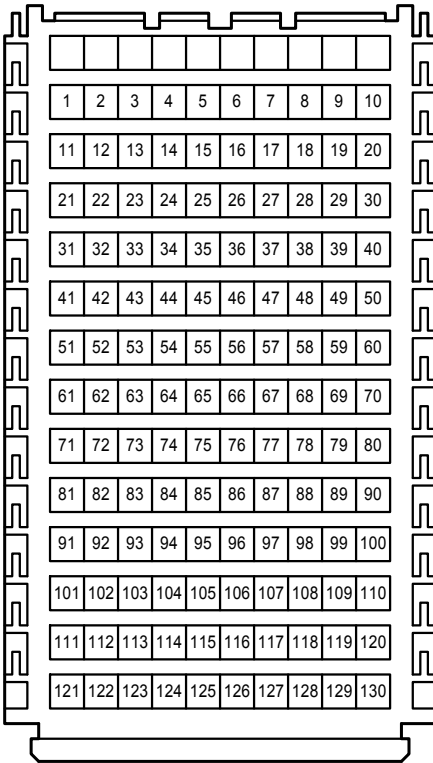

(Manual A/C)

Engine Control

J 19
White

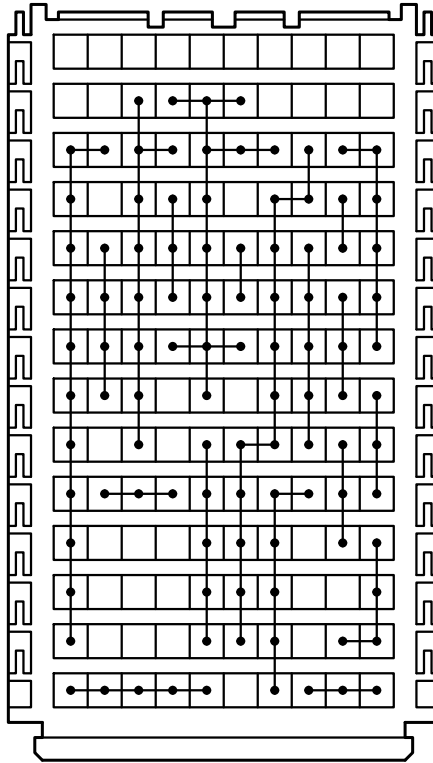
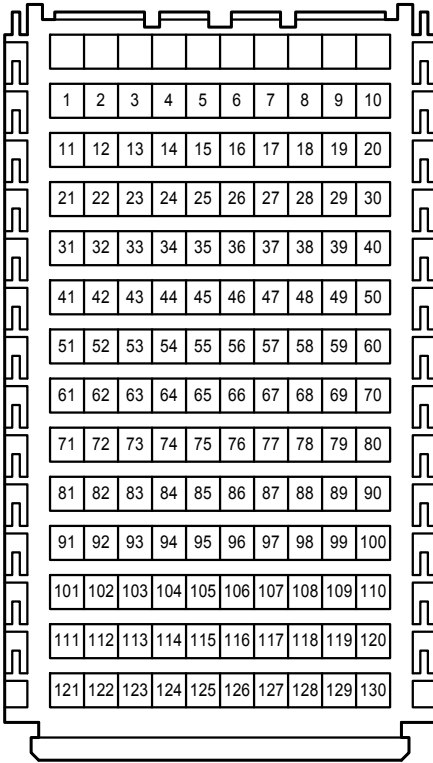

J 20
White

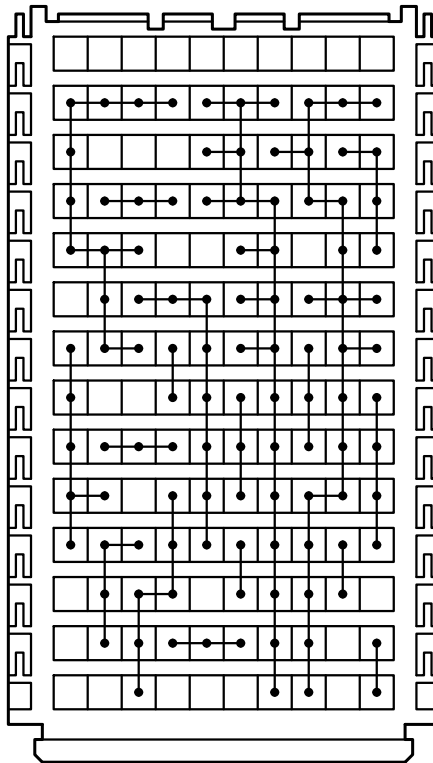
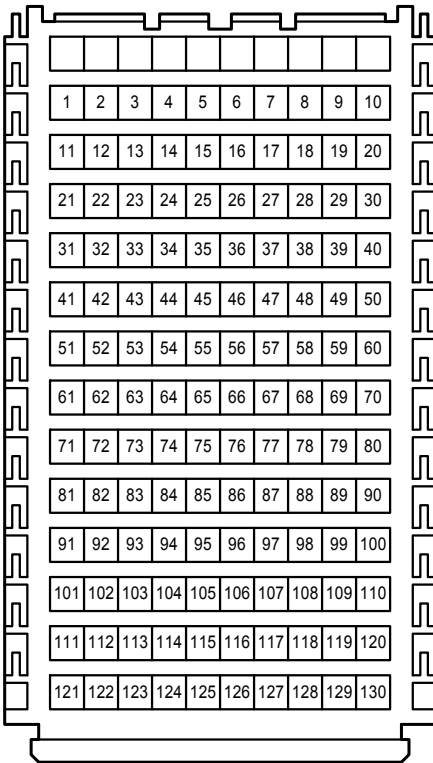

J 21
White

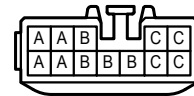

Engine Control

J 47
Blue

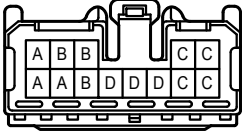

J 48
Black

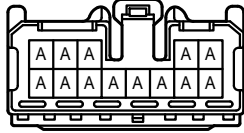

J 49
White

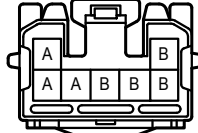

K 5
Gray

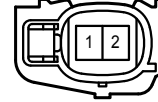

K 6
Black

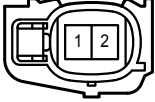

M 6
Black



P 1
Gray

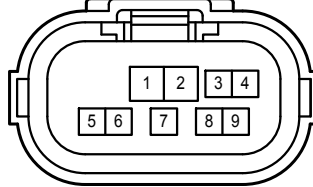

P 4
Black



S 3
Black

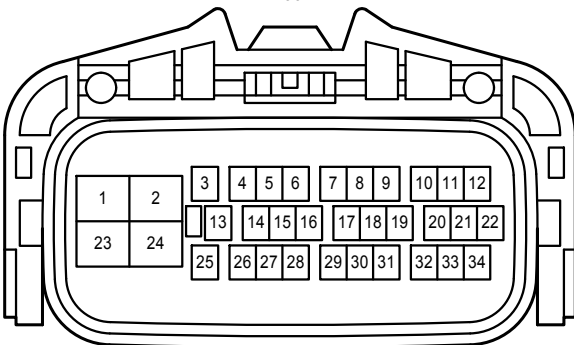

(w/o VSC)

S 3
Black

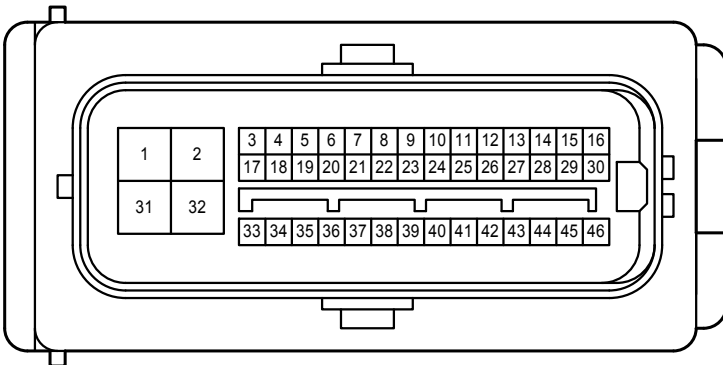

(w/ VSC)

S 12
Blue

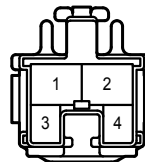

S 34
White

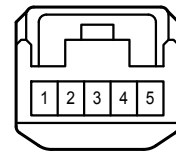

S 35
White

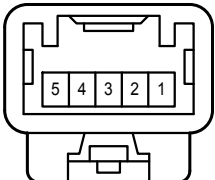

T 2
Black

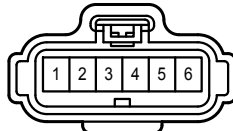

T 6
White

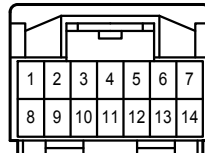

V 2
Black

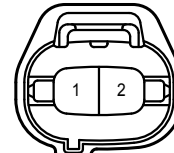

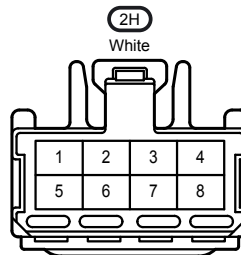
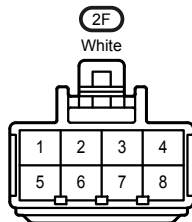
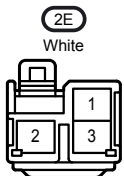
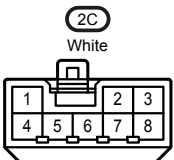
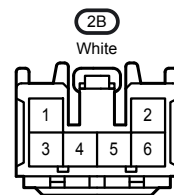
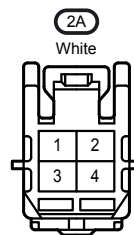
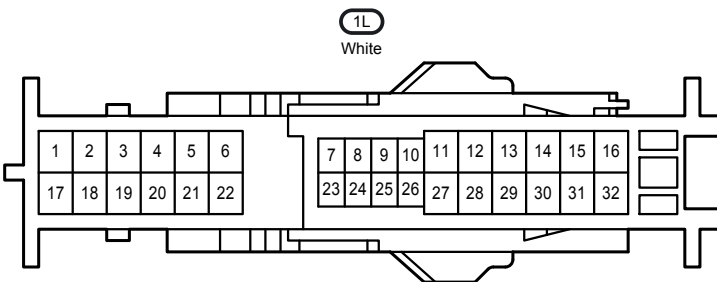
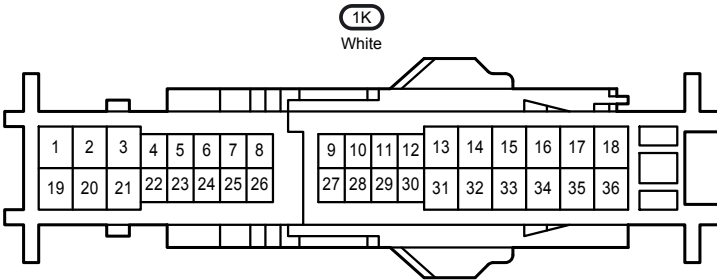
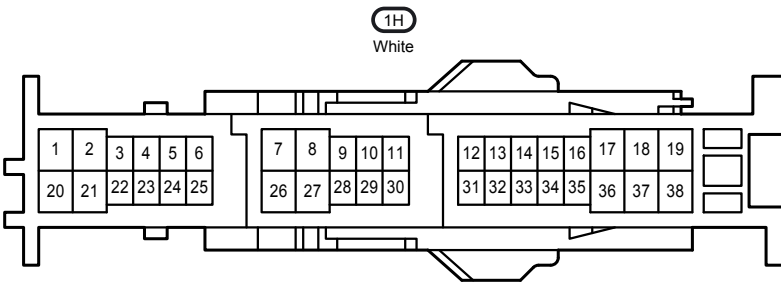
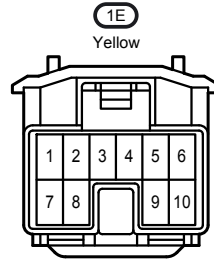
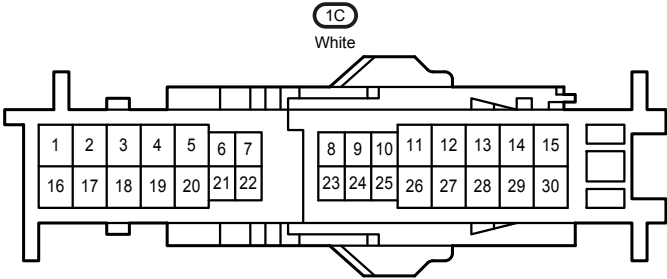
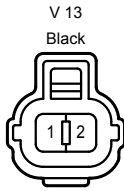
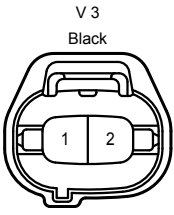

Engine Control

BC1
Black

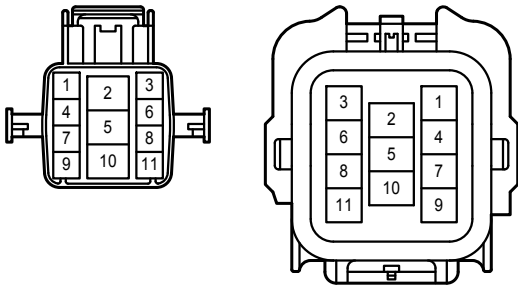

EA1
Gray

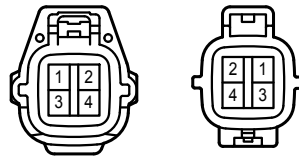

IB1
White

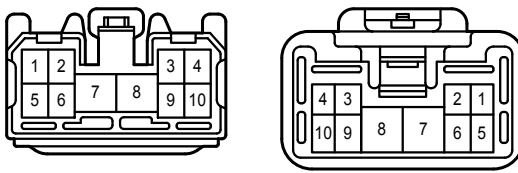

II1
Gray White

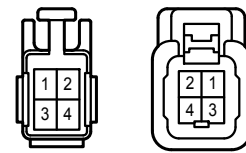

II2
White

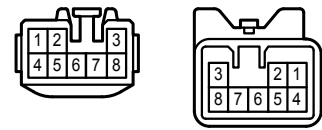

II3
White

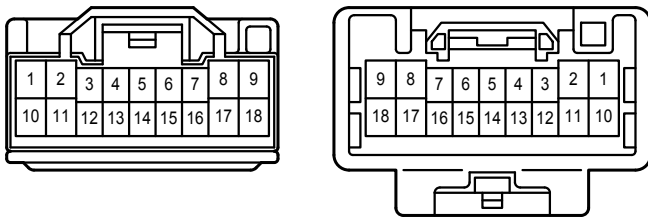

IJ1
White

