

Engine Control <1GR-FE>

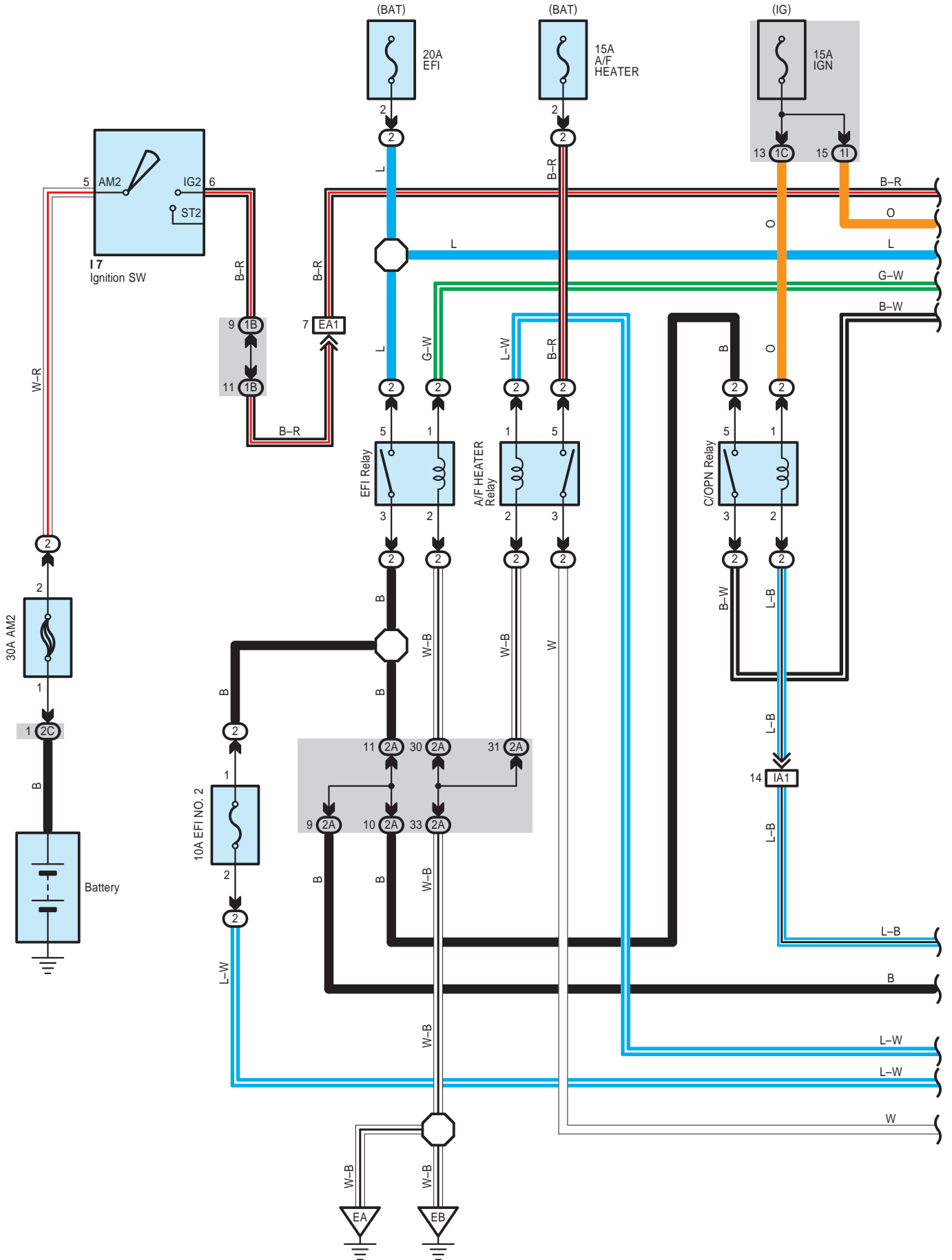

Engine Control <1GR-FE>

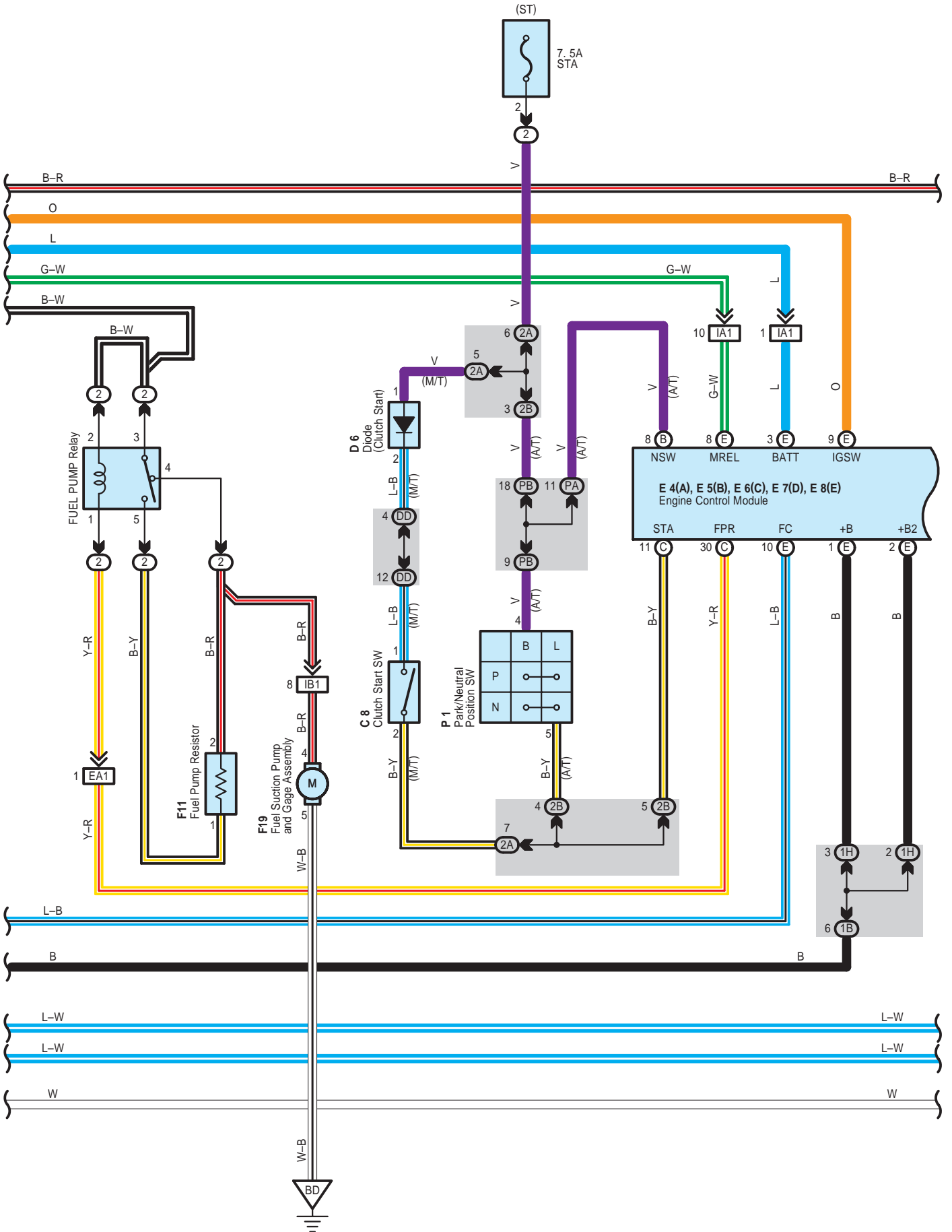

- * 1 : Shielded
- * 2 : w/ VSC
- * 3 : w/o VSC

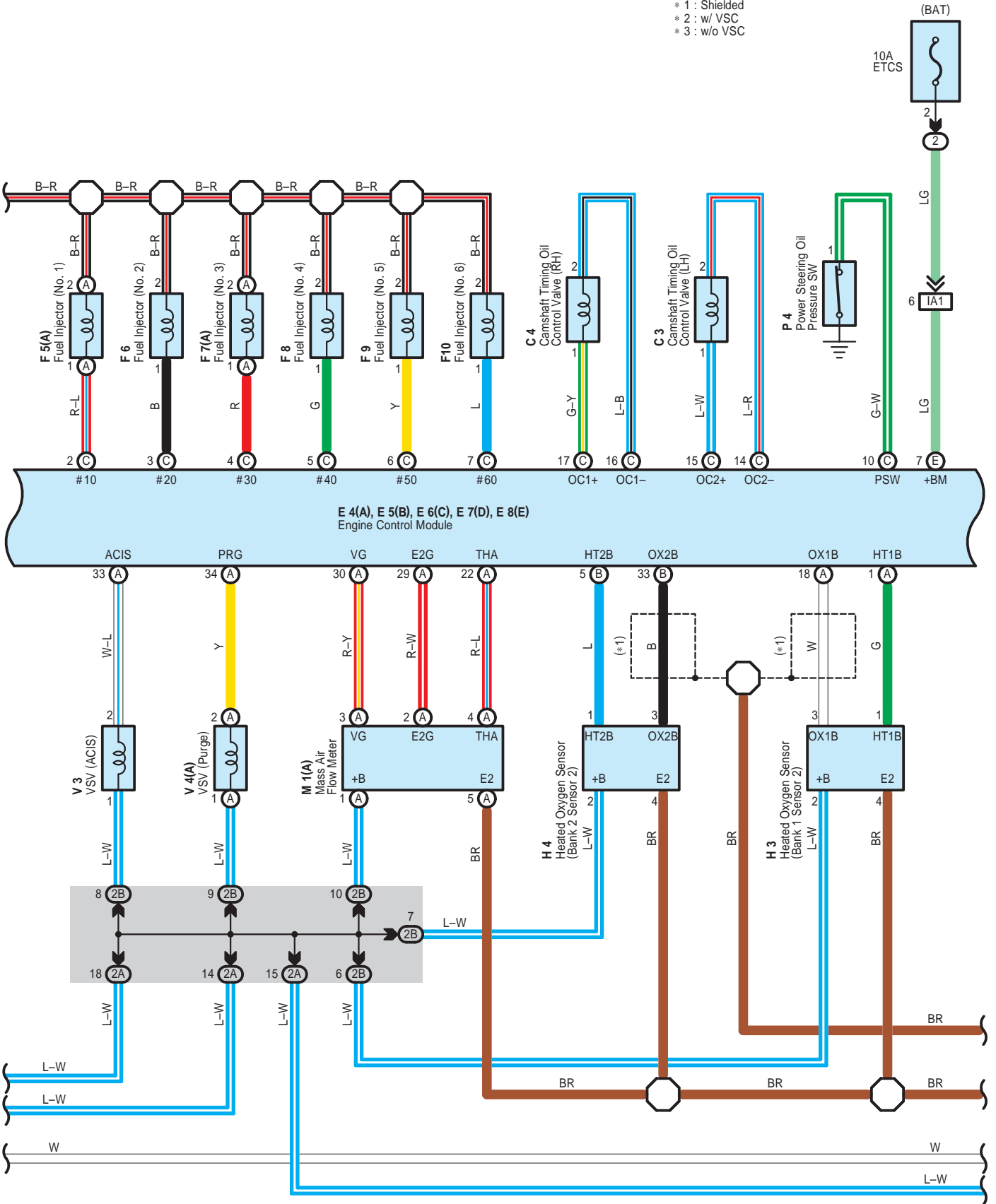

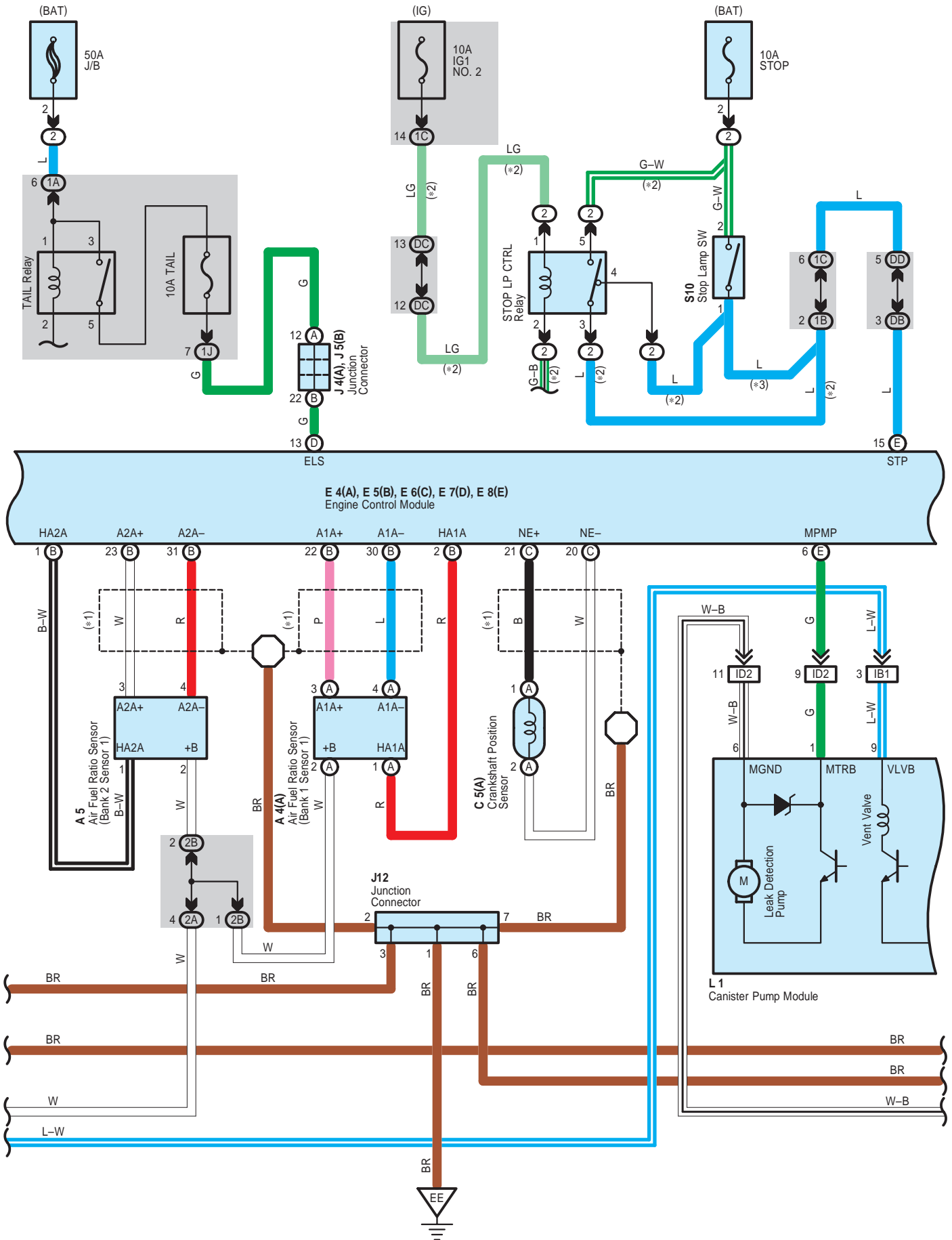

Engine Control <1GR-FE>

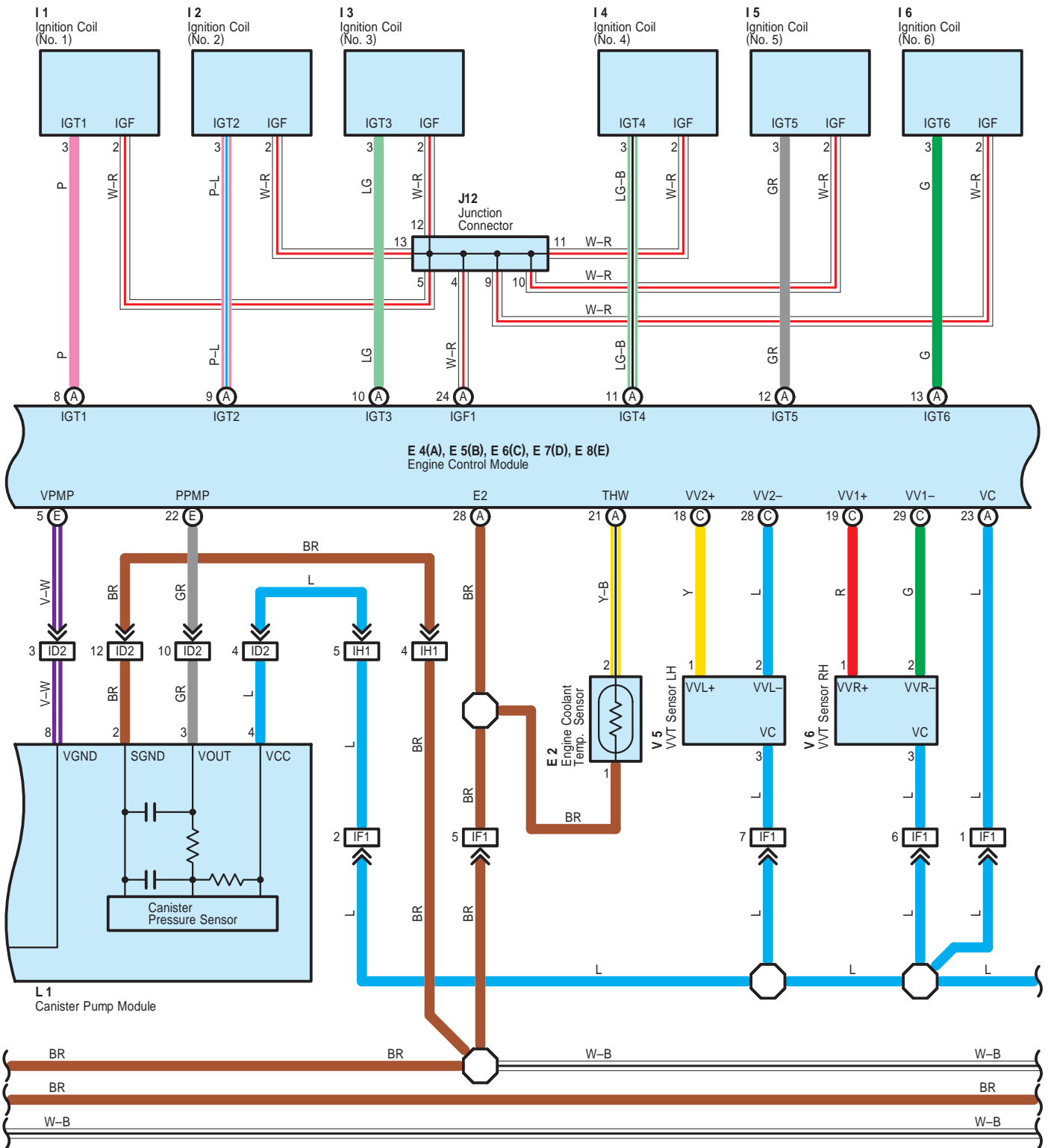

* 1 : Shielded

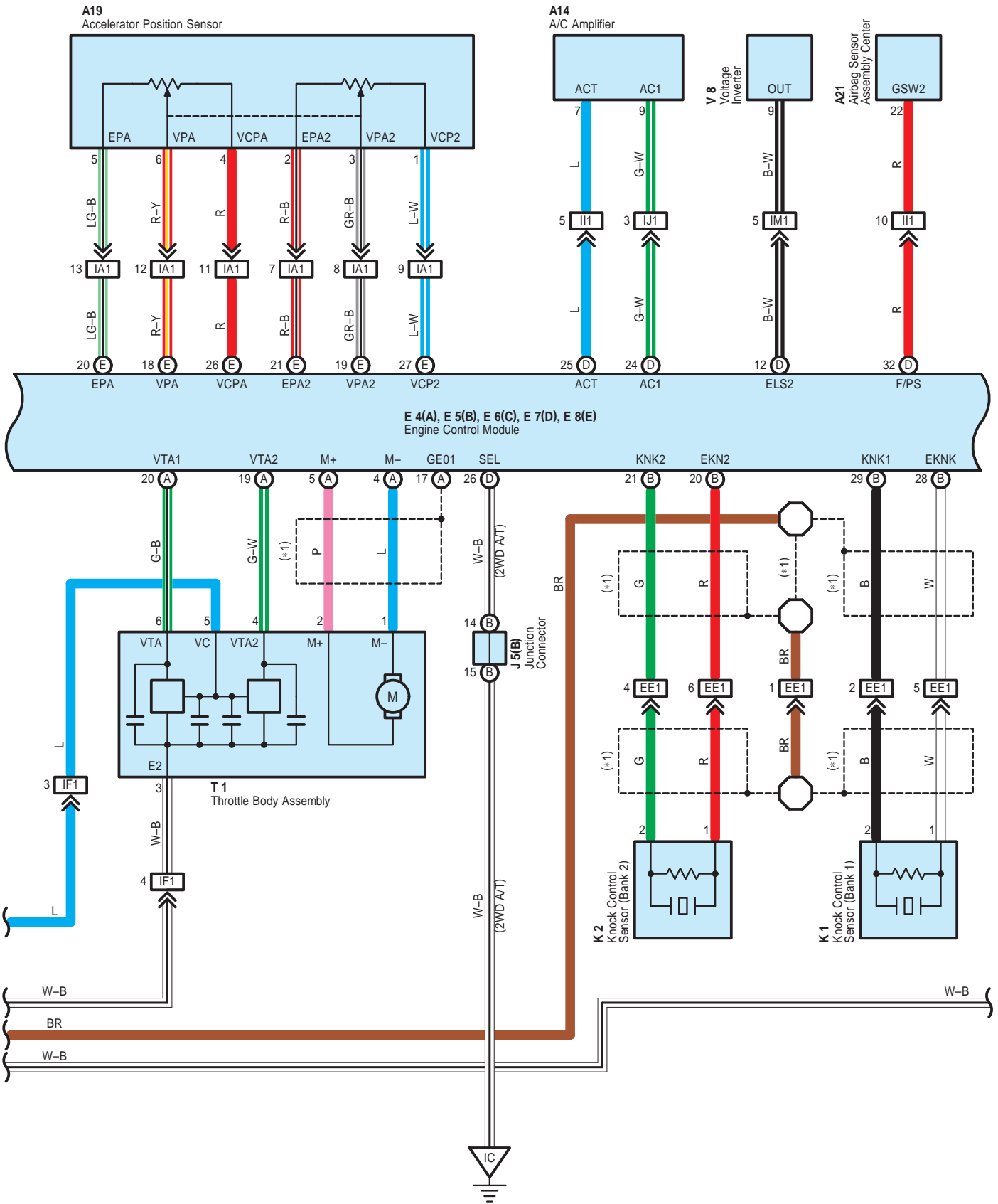

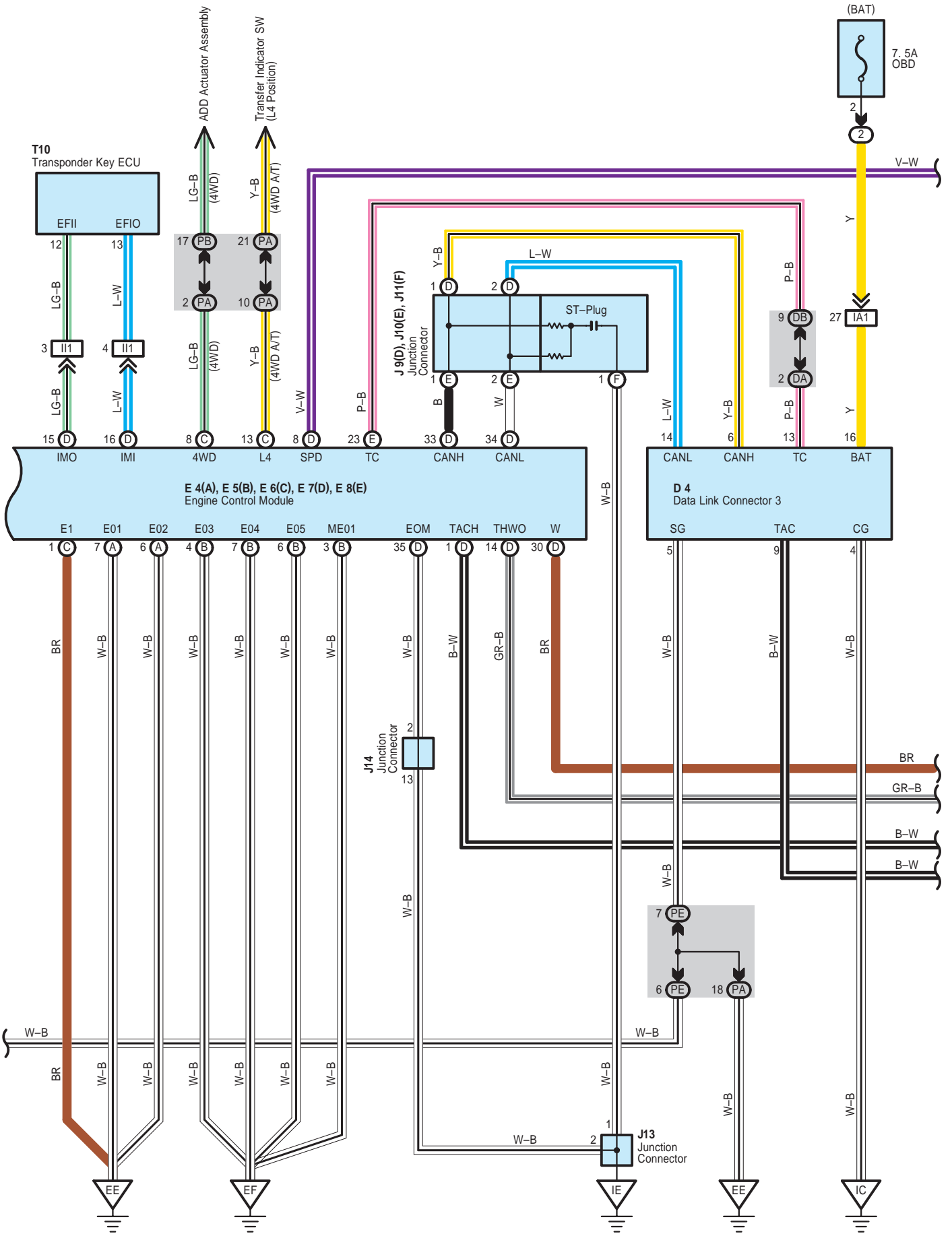

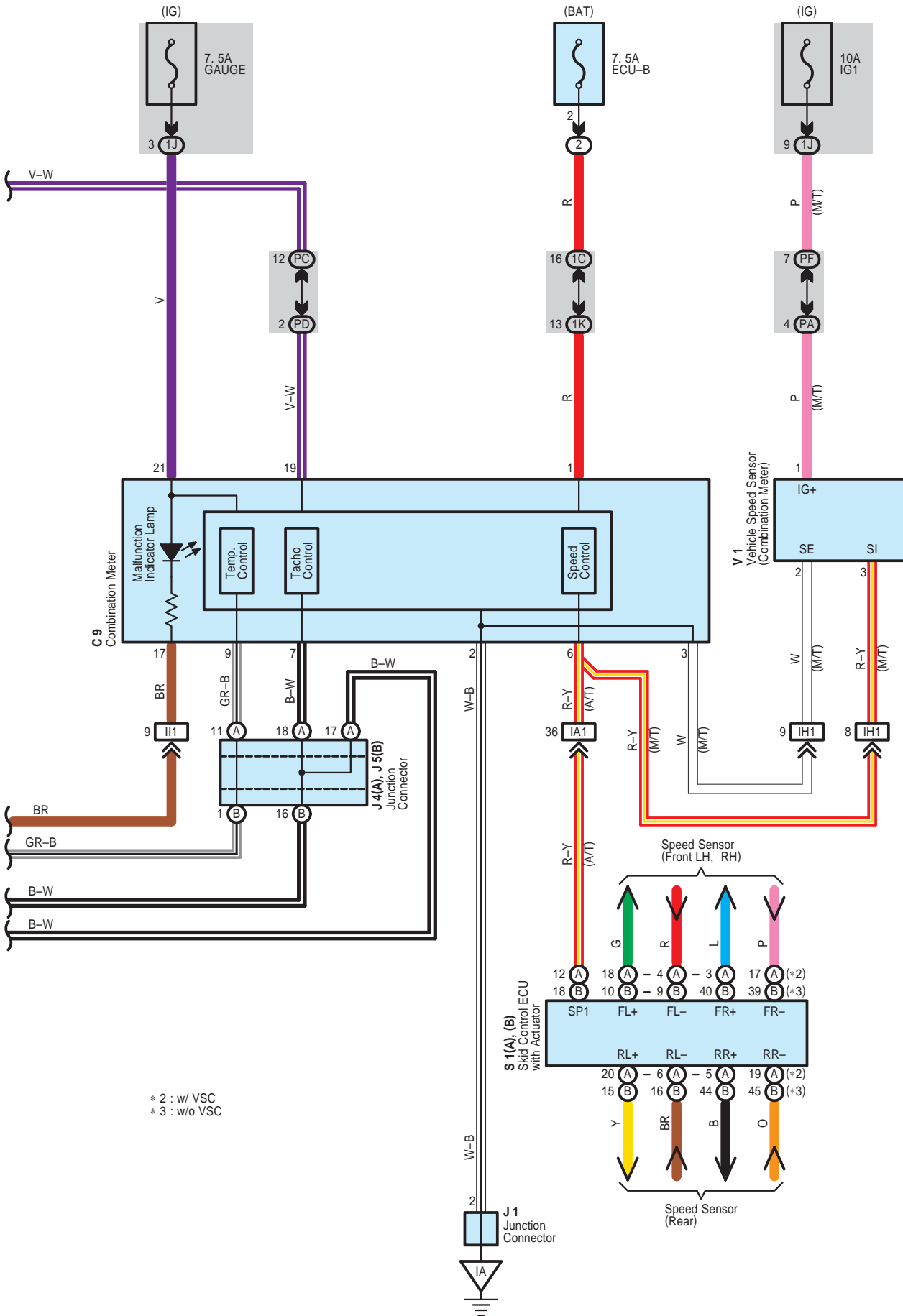

Engine Control <1GR-FE>

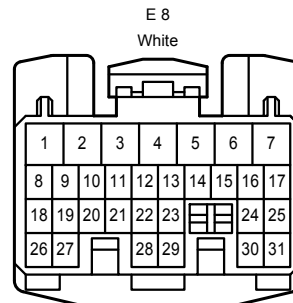
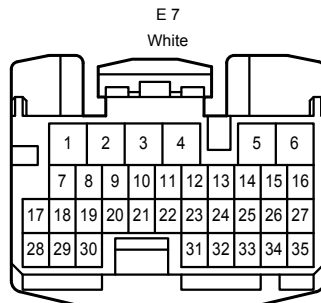
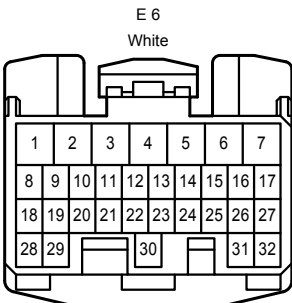
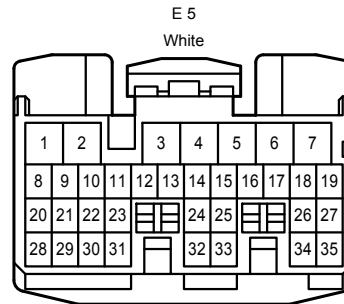
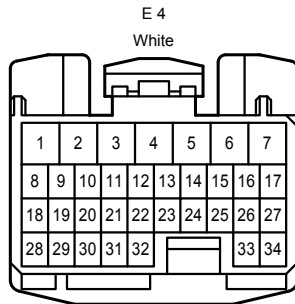
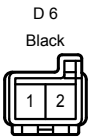
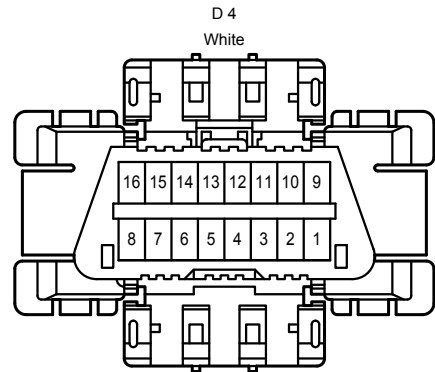
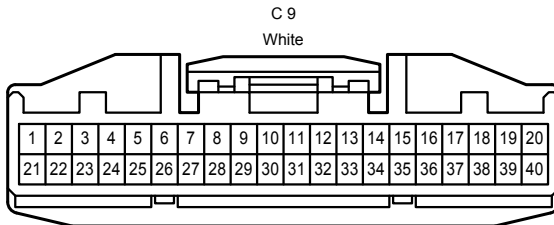
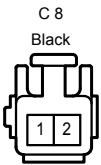
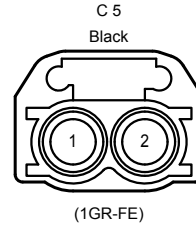
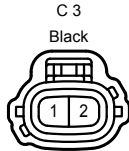
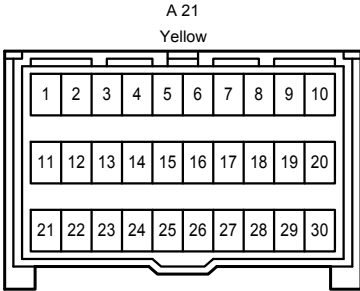
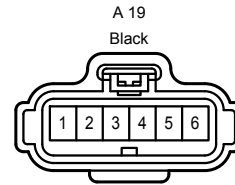
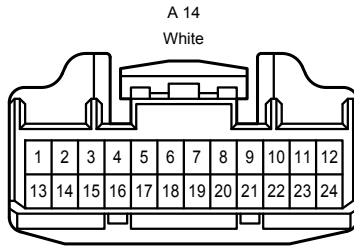

Engine Control <1GR-FE>

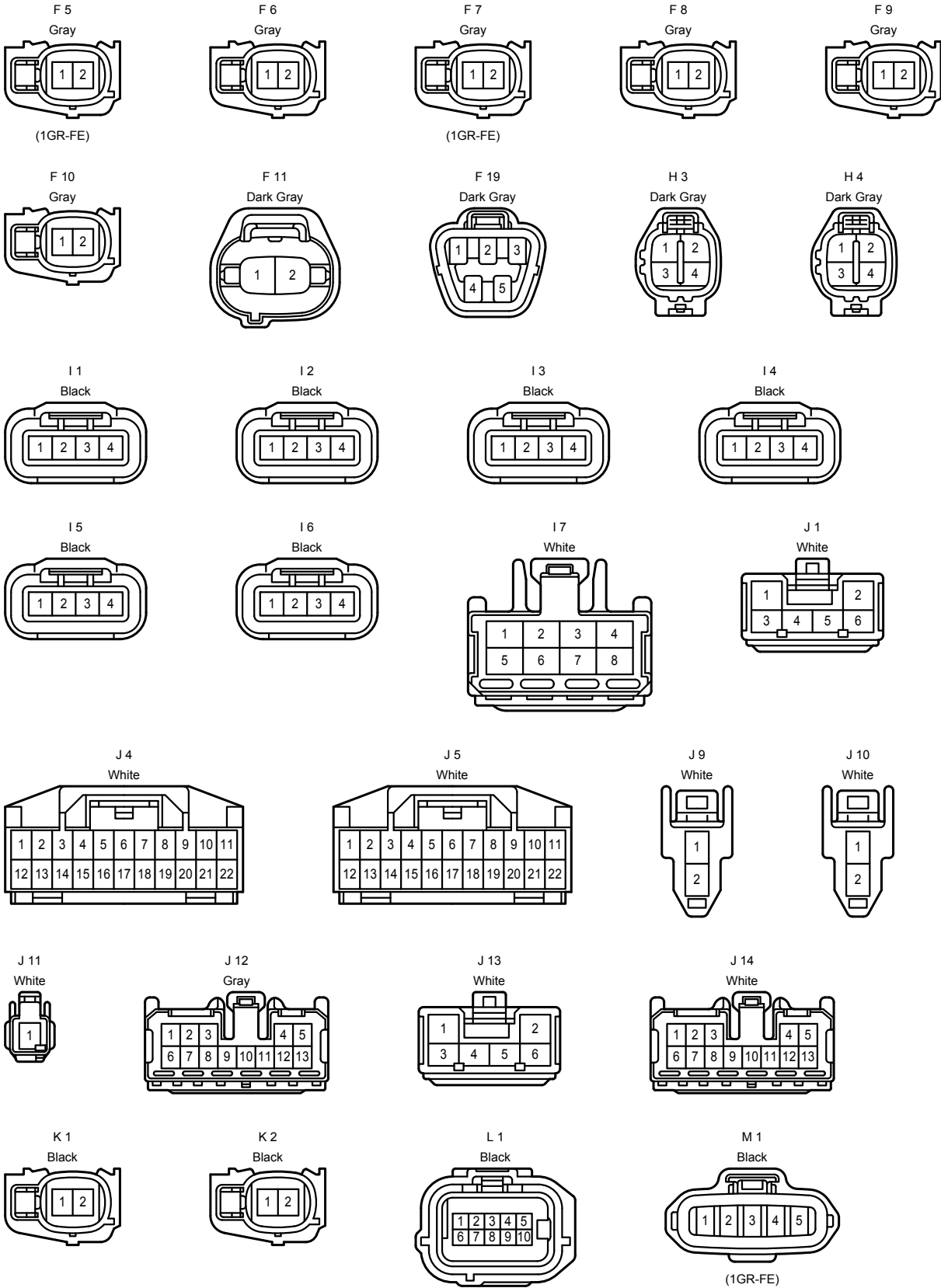

P 1
Gray

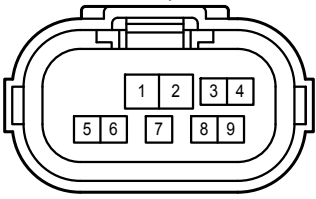

P 4
Black



S 1
Gray

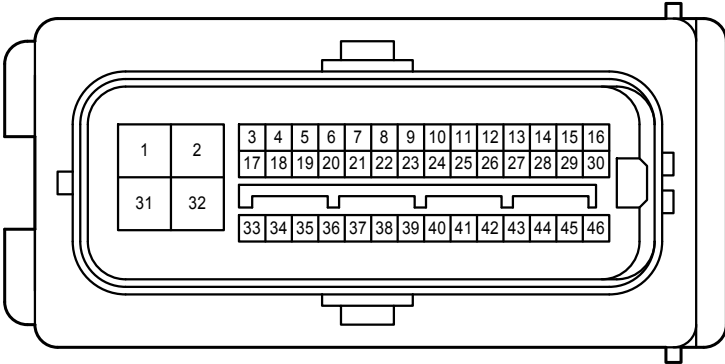

(w/o VSC)

S 1
Black

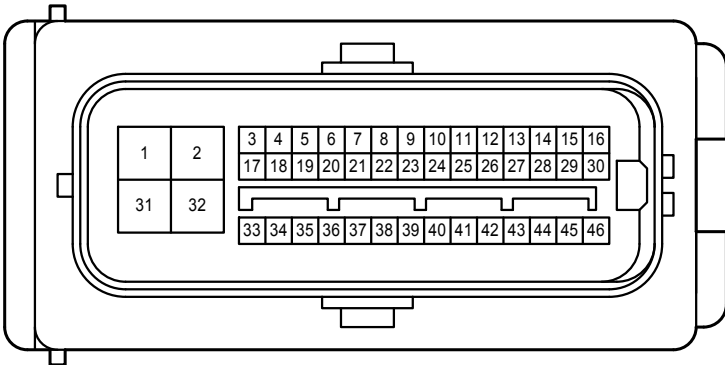

(w/ VSC)

S 10
Blue

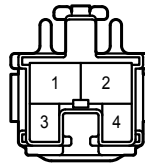

T 1
Black

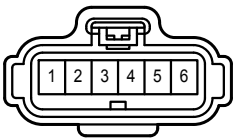

T 10
White

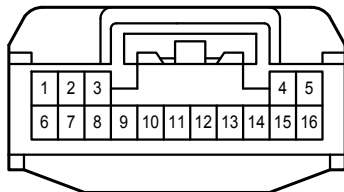

V 1
Black



V 3
Black

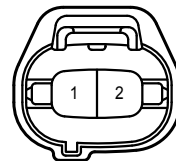

V 4
Gray

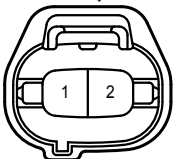

(1GR-FE)

V 5
Black

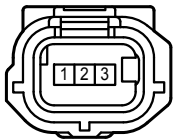

V 6
Black

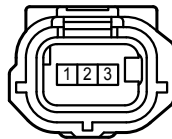

V 8
White

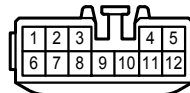

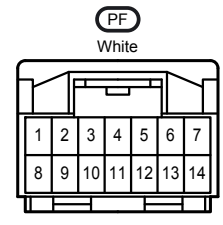
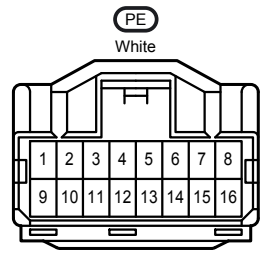
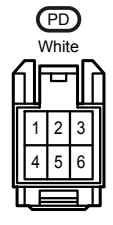
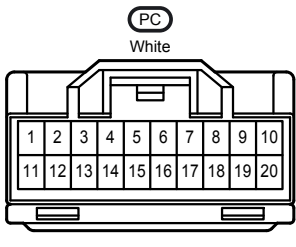
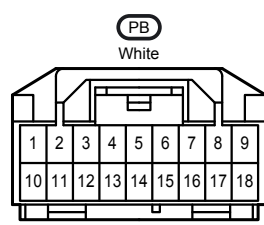
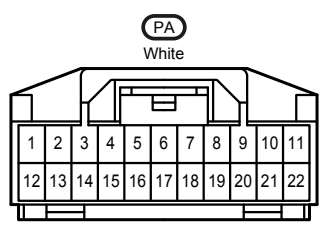
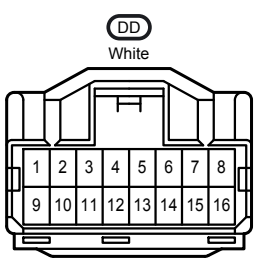
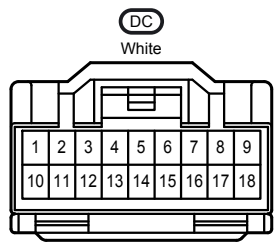
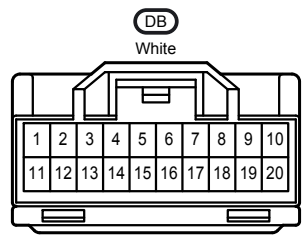
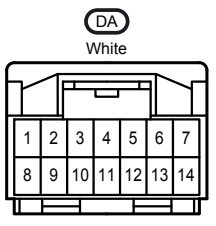
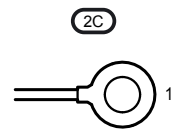
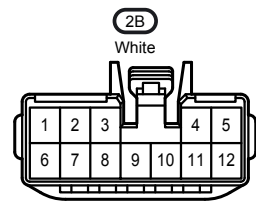
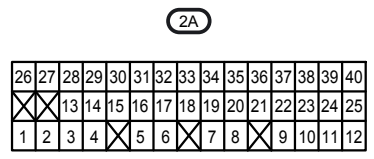
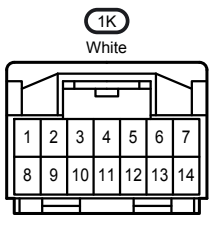
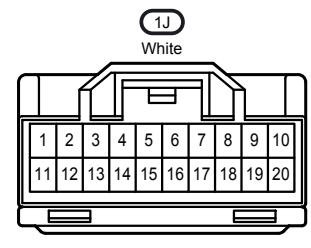
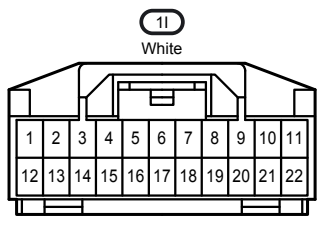
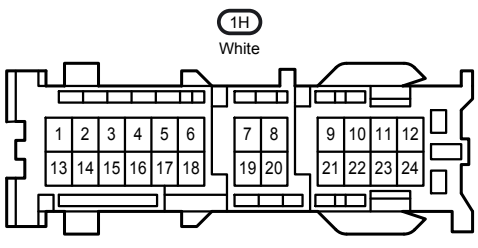
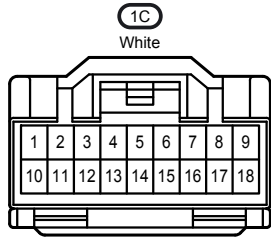
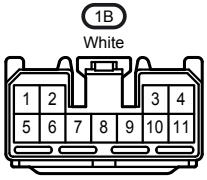
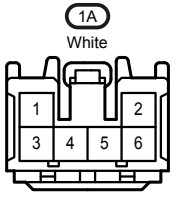

Engine Control <1GR-FE>

EA1
White

EE1
Dark Gray

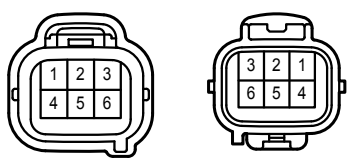
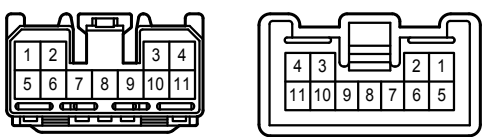

IA1
Gray

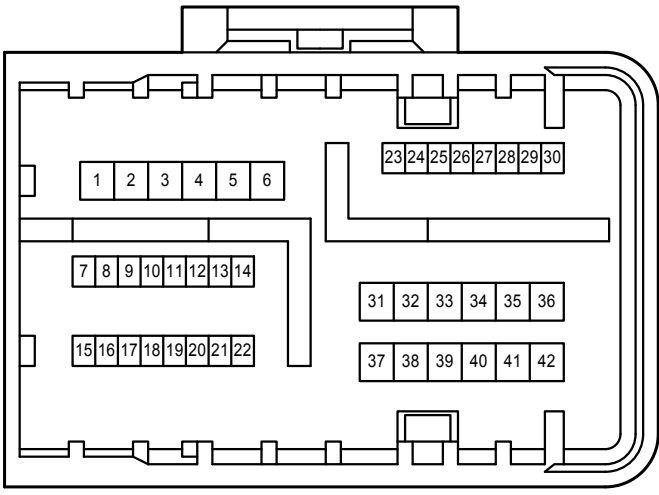
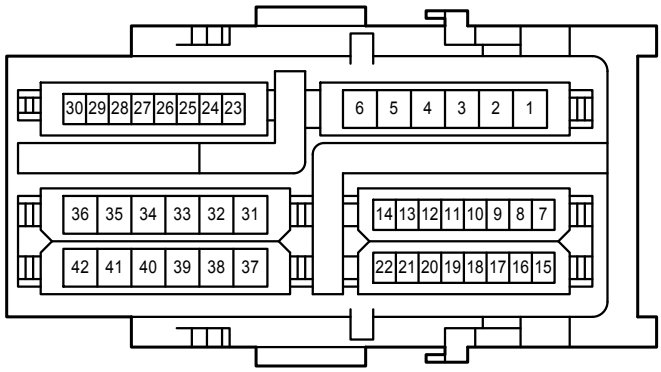

IB1
White

ID2
Gray

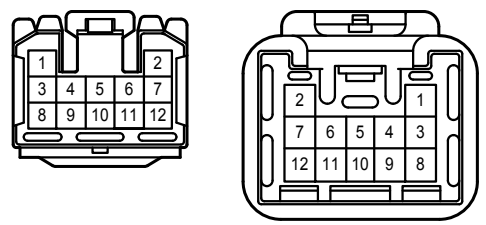
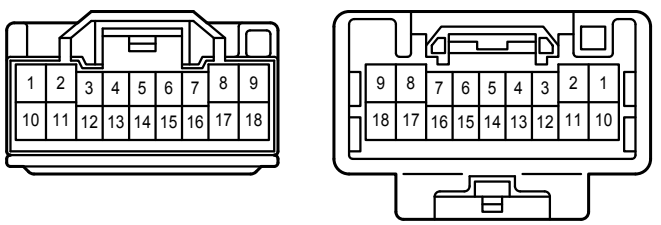

IF1
White

IH1
Black

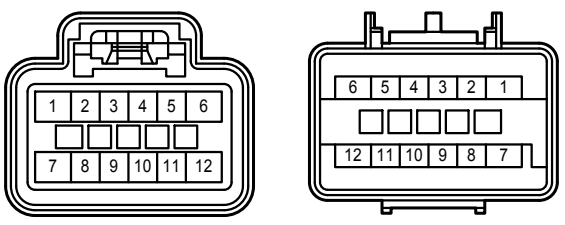
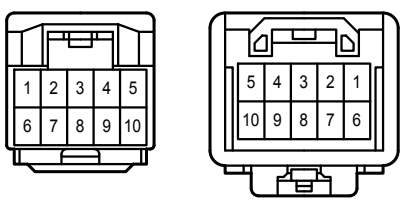

II1
White

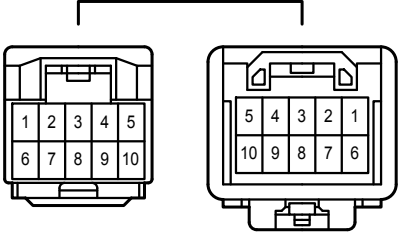

IJ1
White

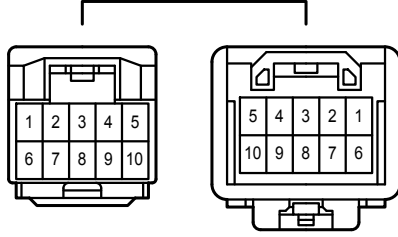

IM1
White

