

Engine Control <2GR-FSE>

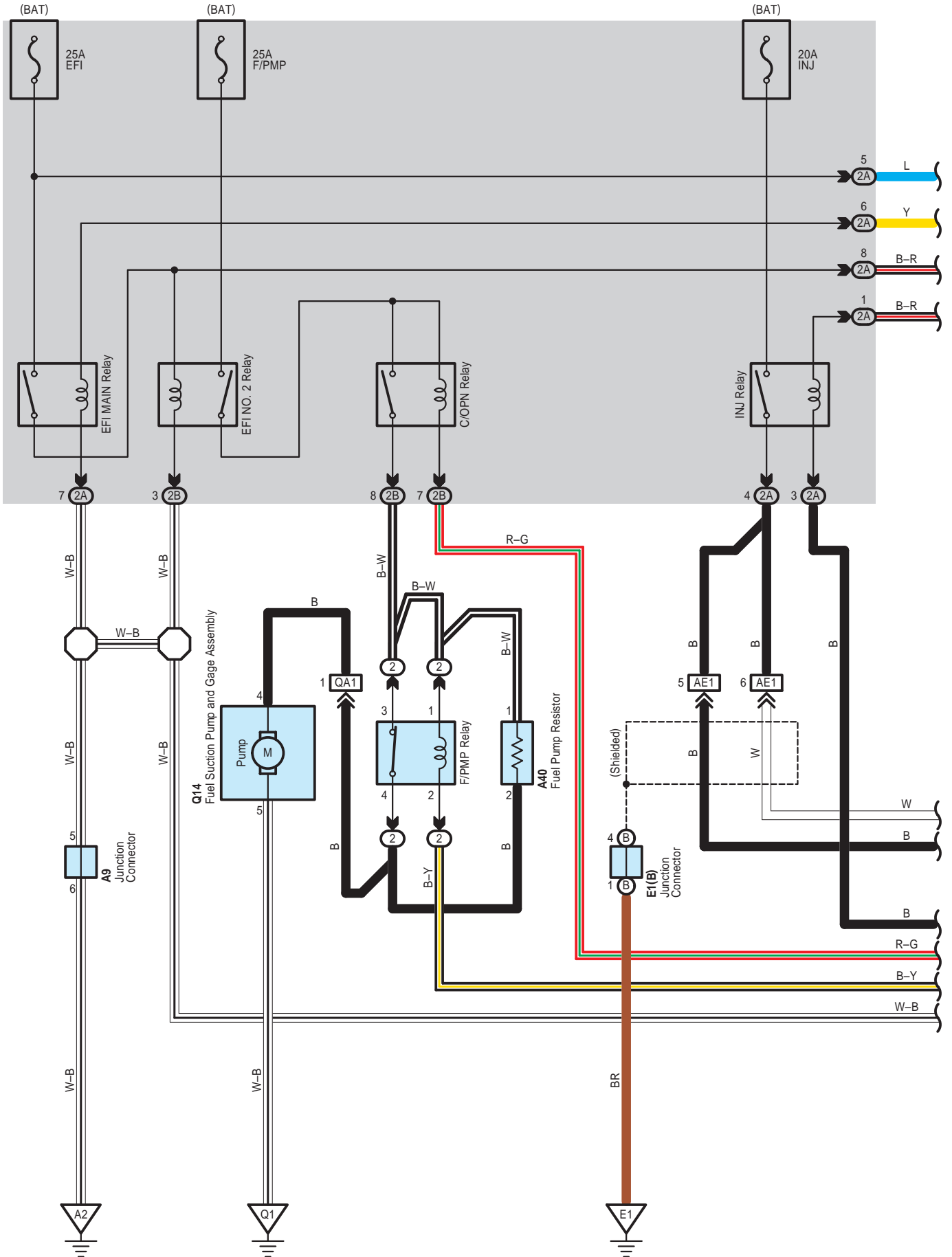

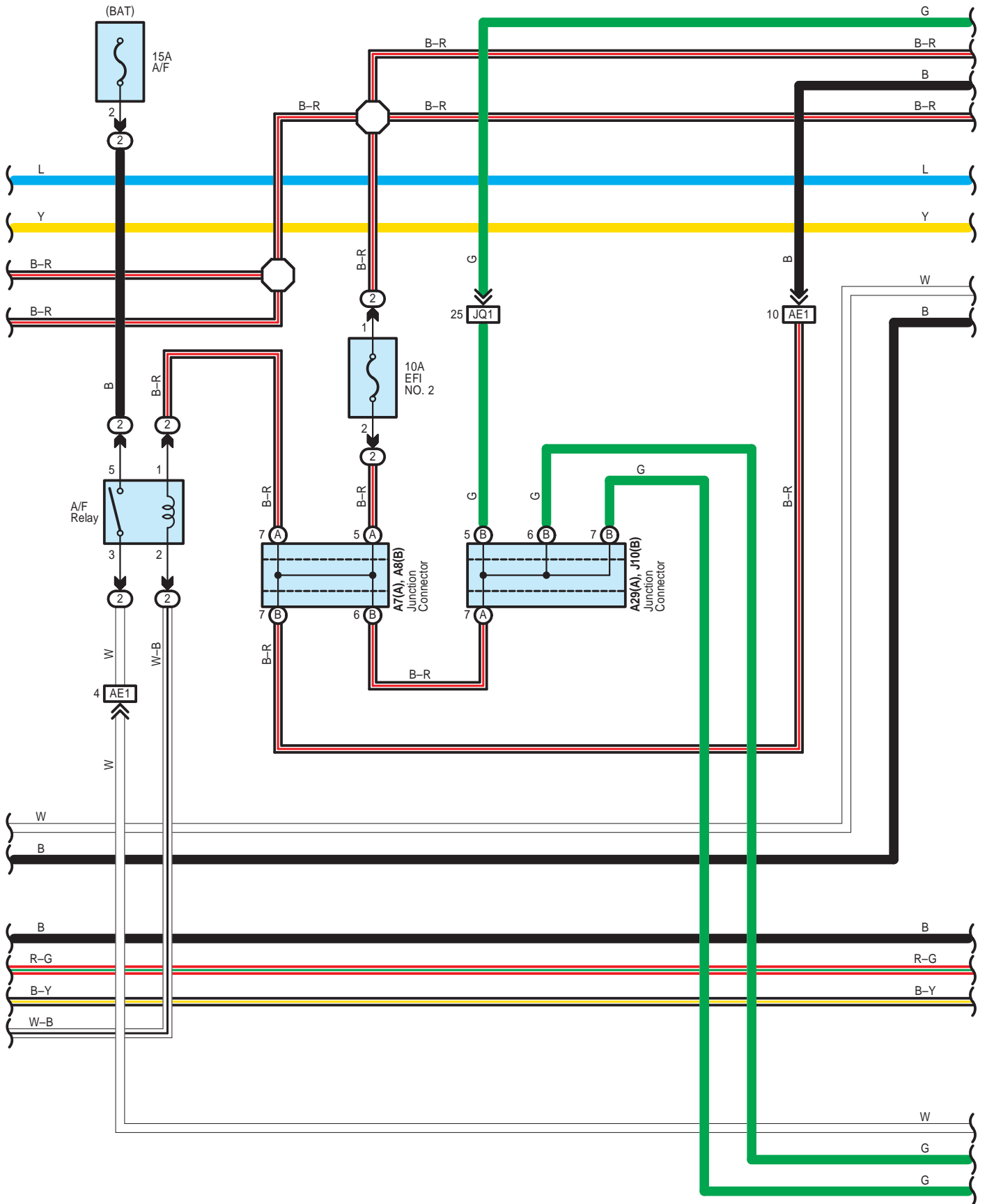

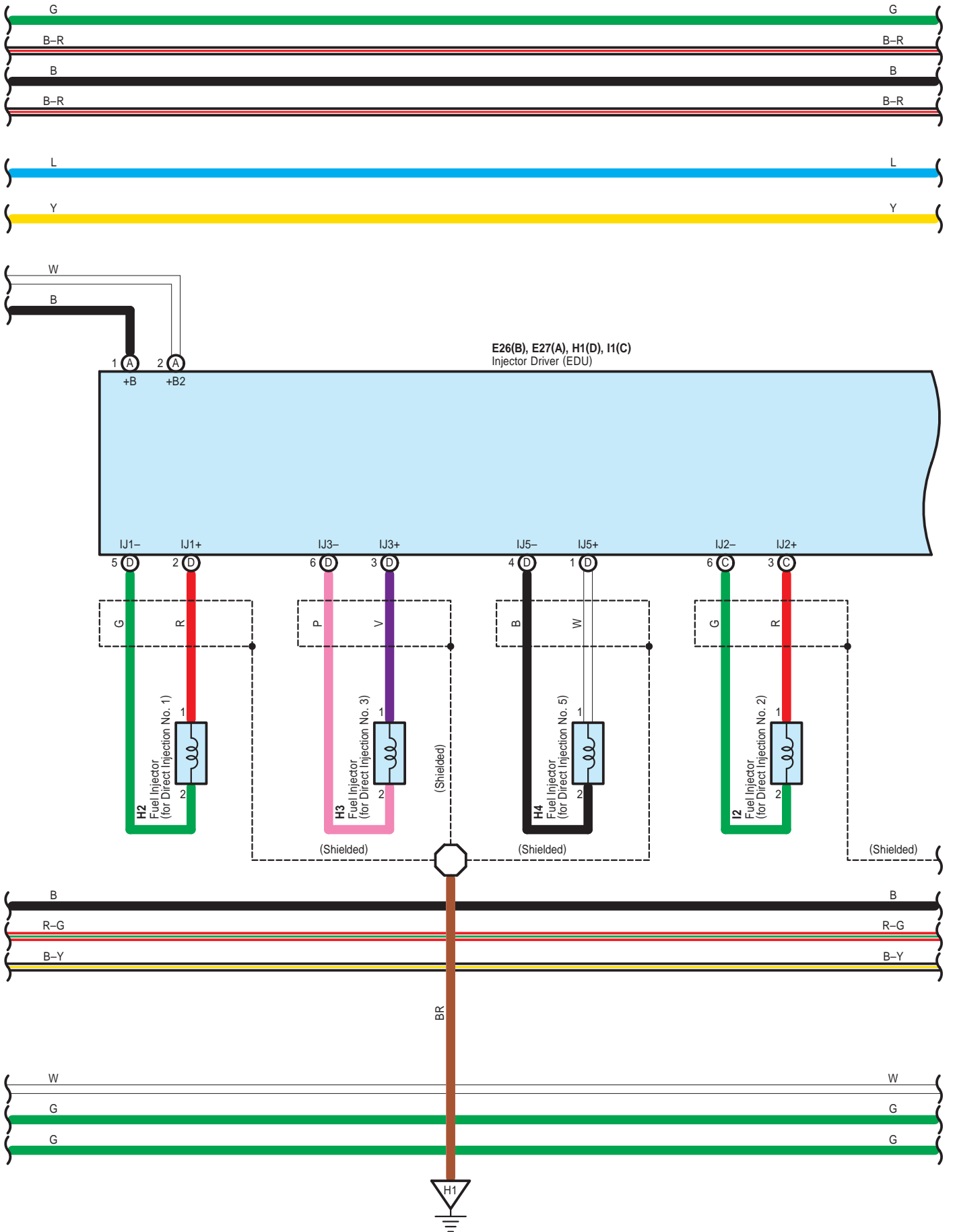

Engine Control <2GR-FSE>

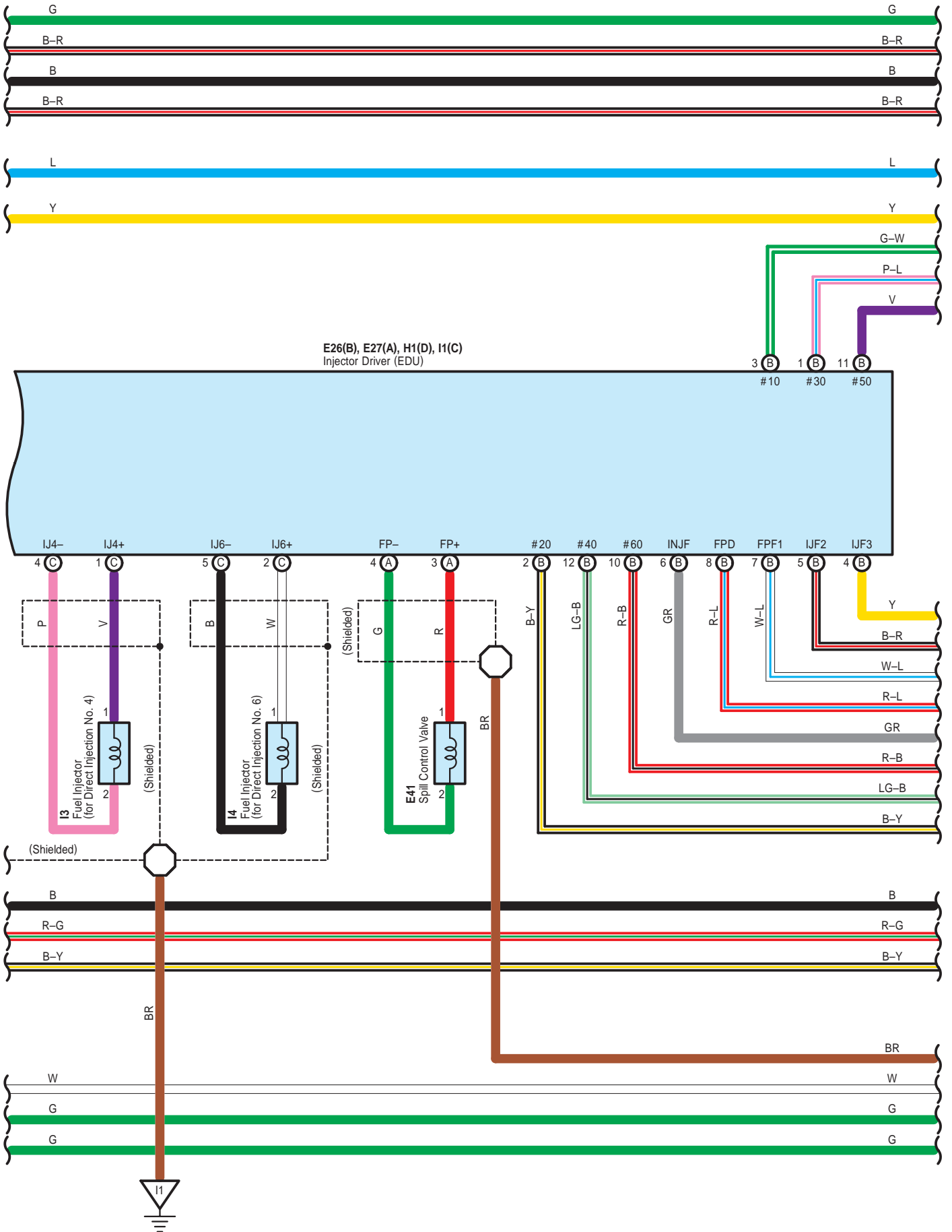

Engine Control <2GR-FSE>

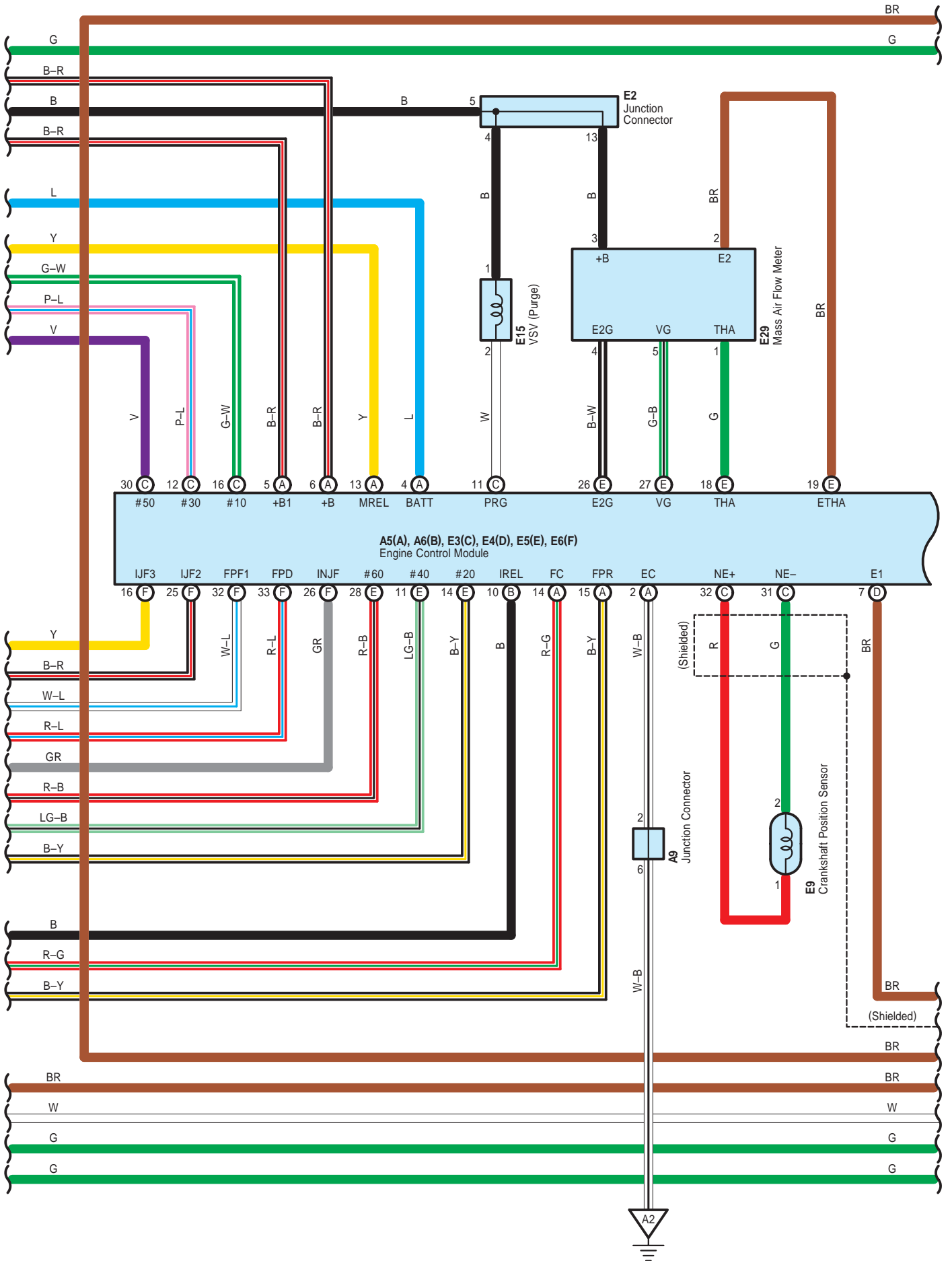

Engine Control <2GR-FSE>

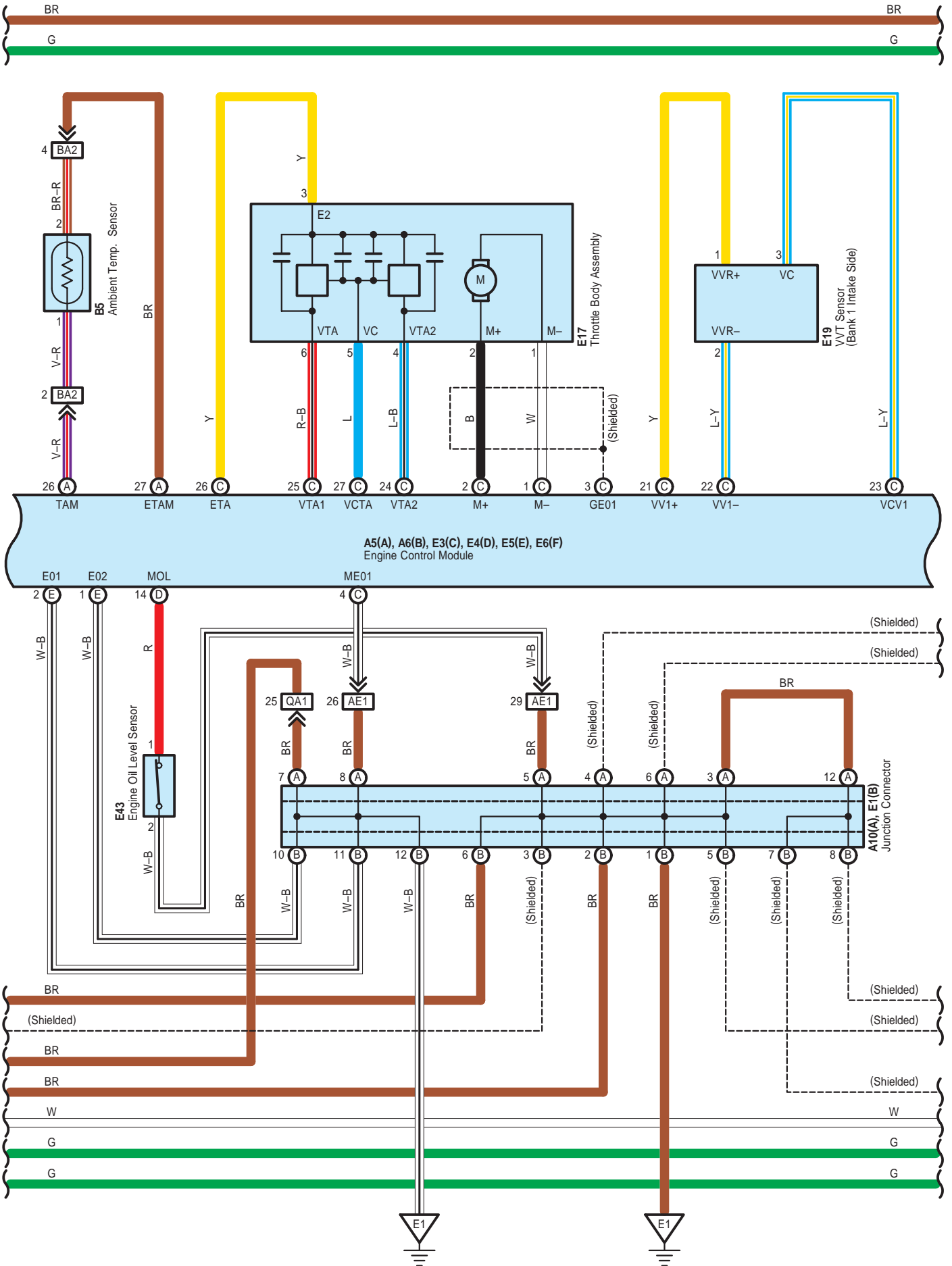

Engine Control <2GR-FSE>

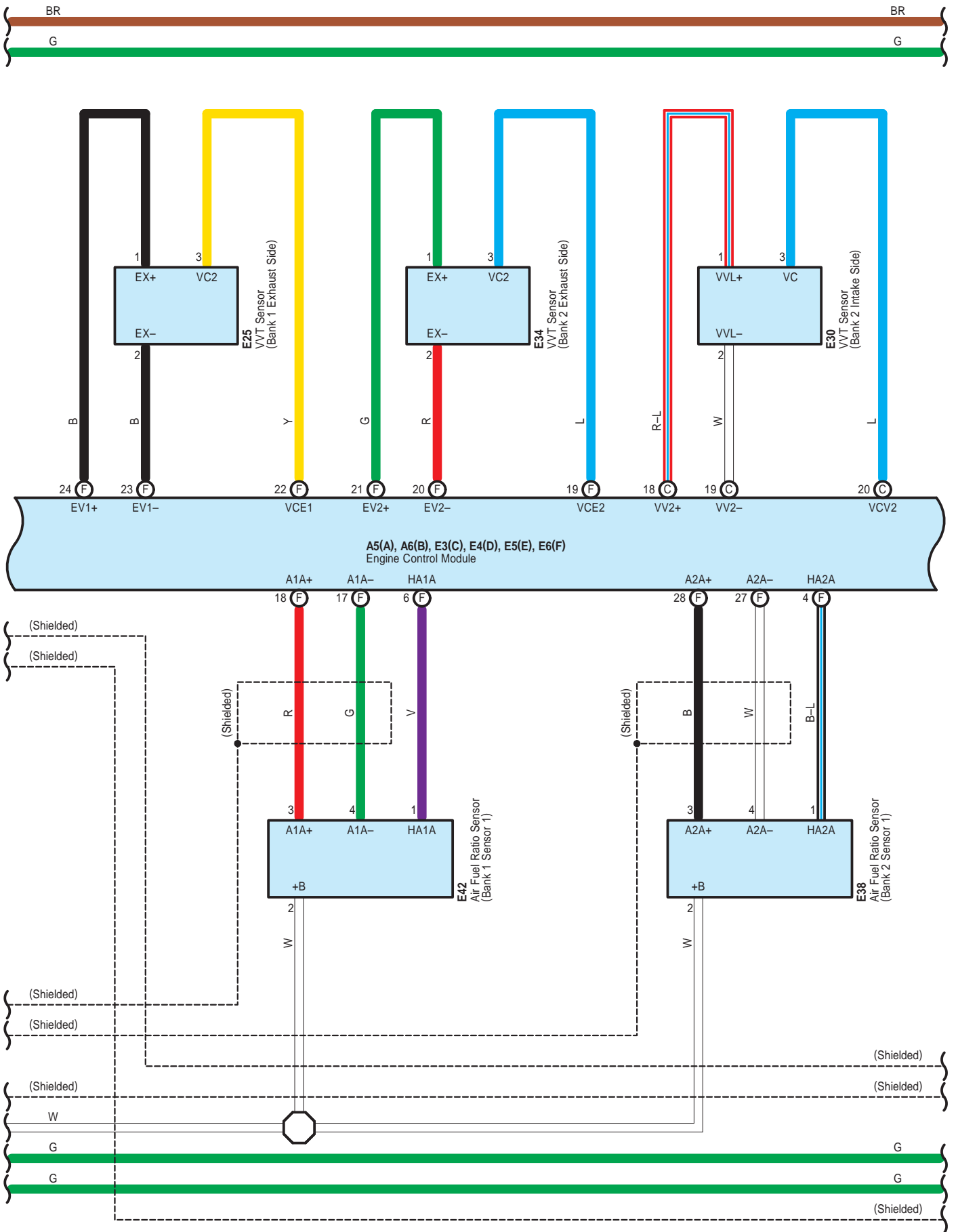

Engine Control <2GR-FSE>

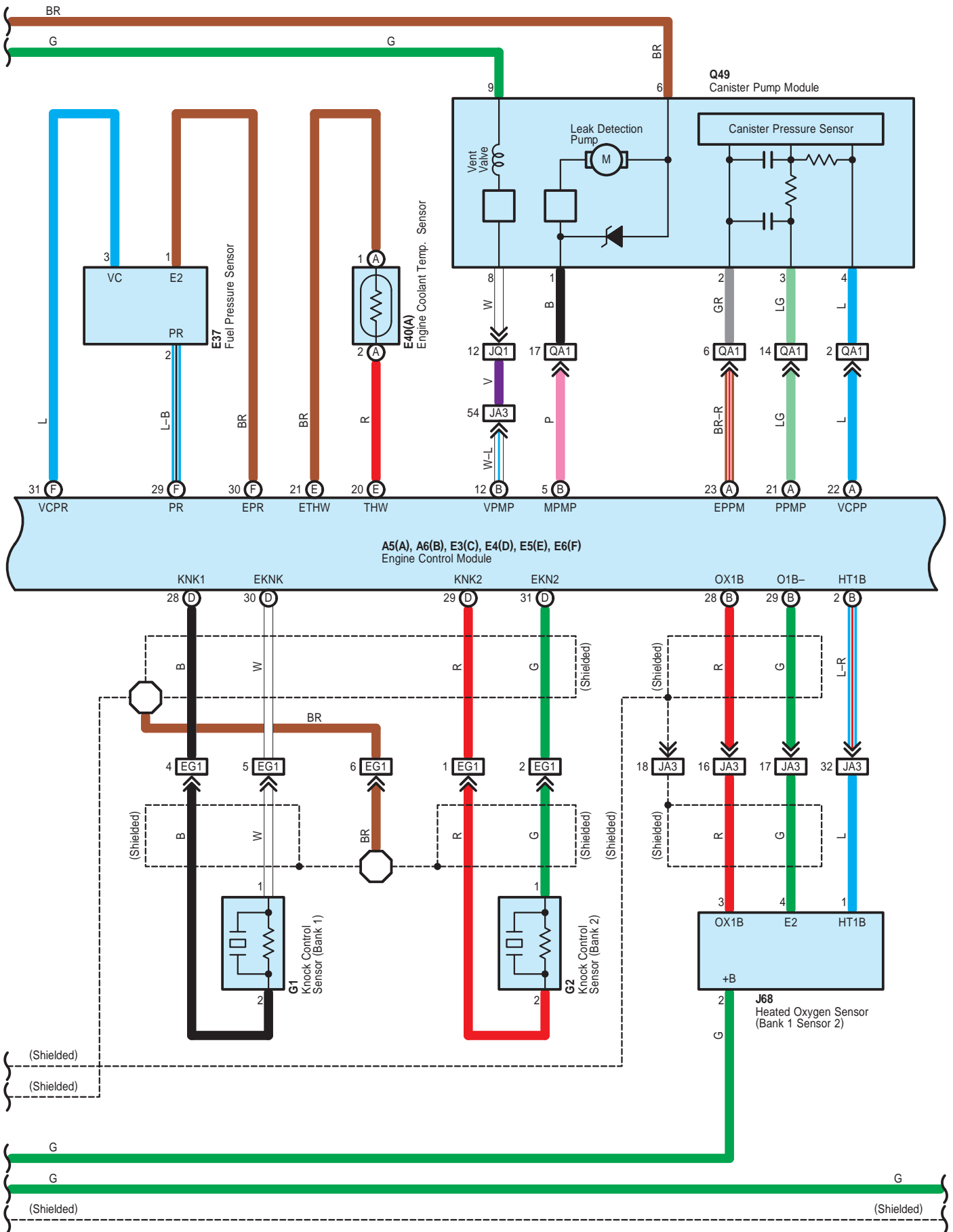

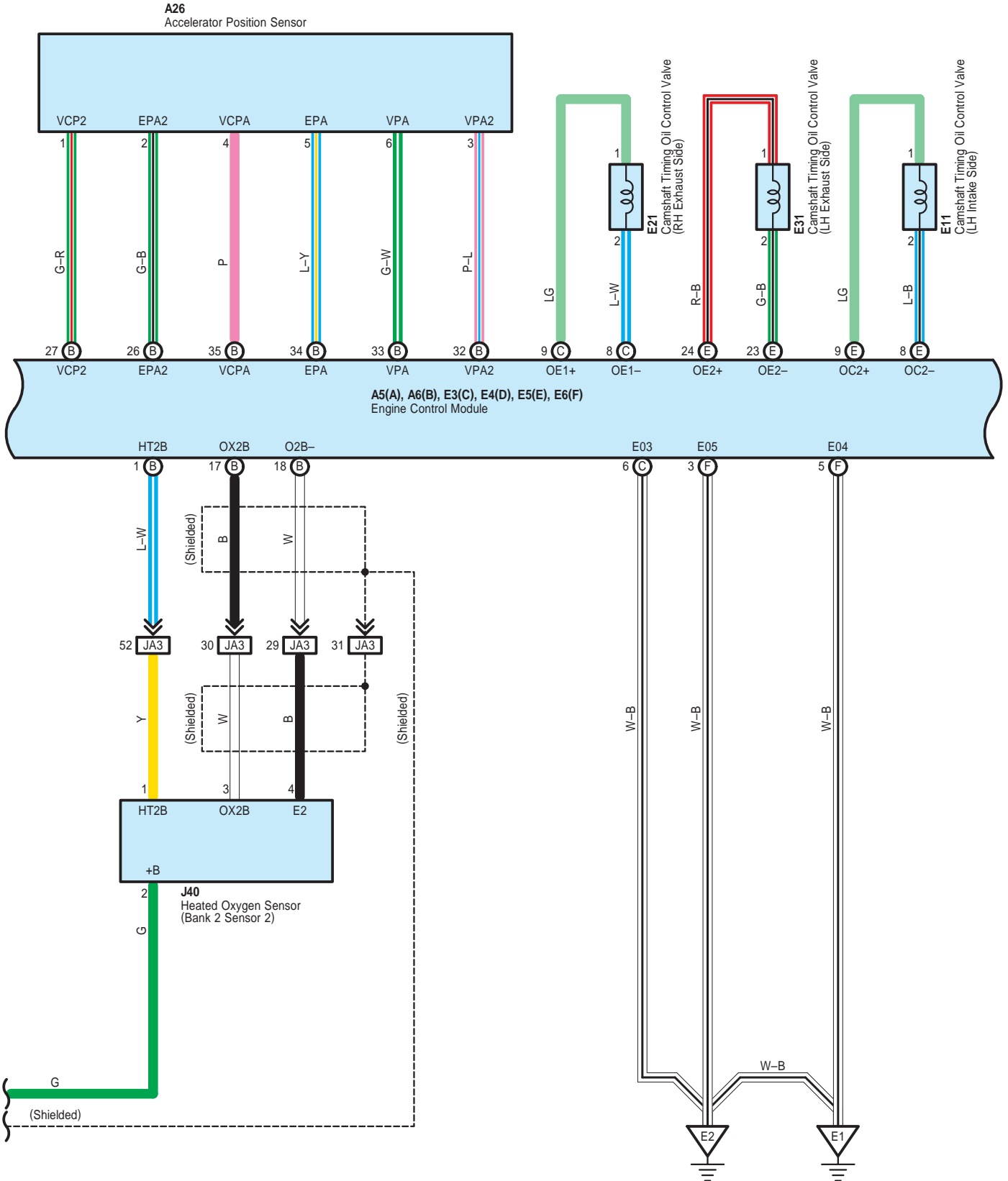

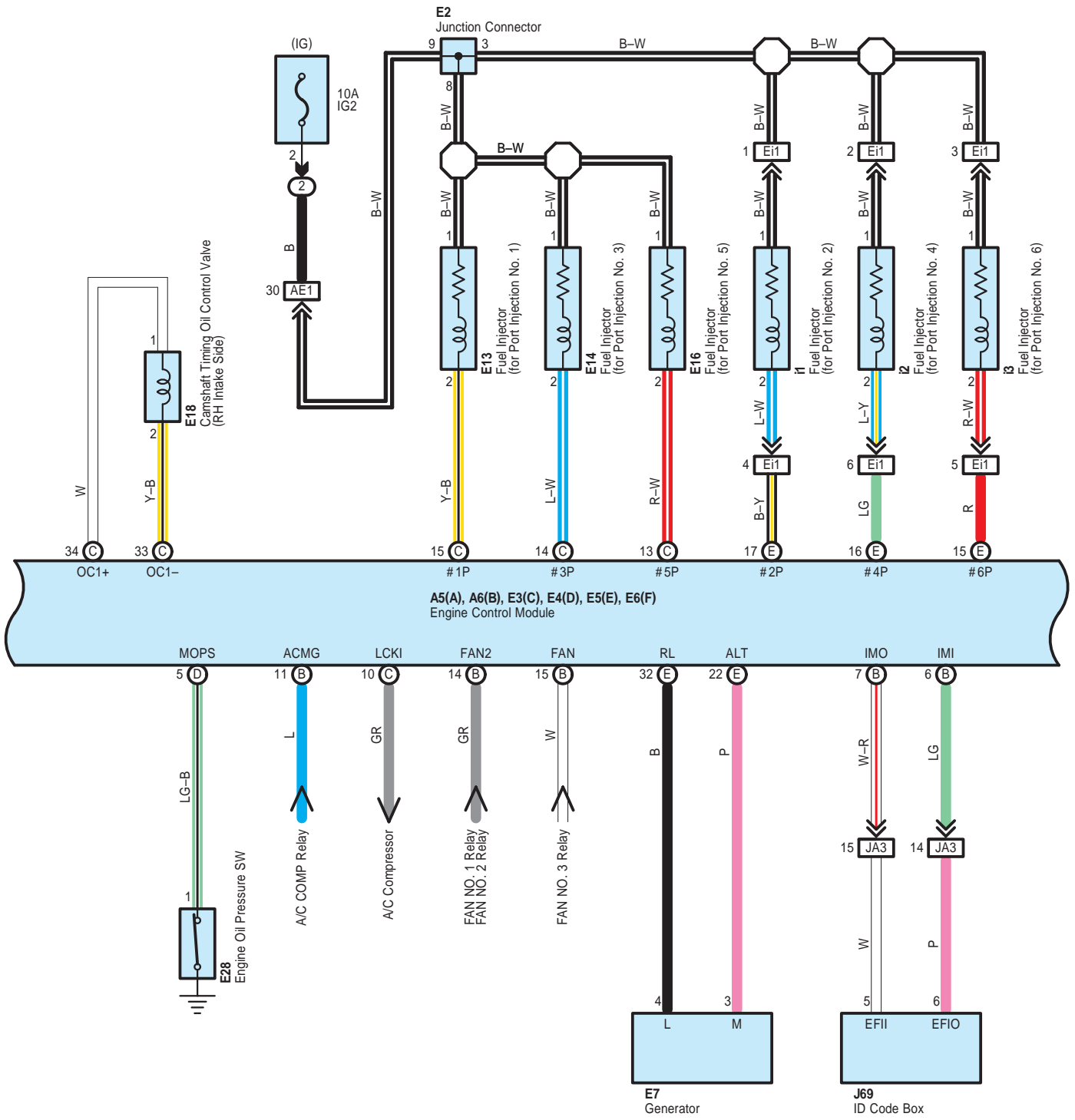

Engine Control <2GR-FSE>

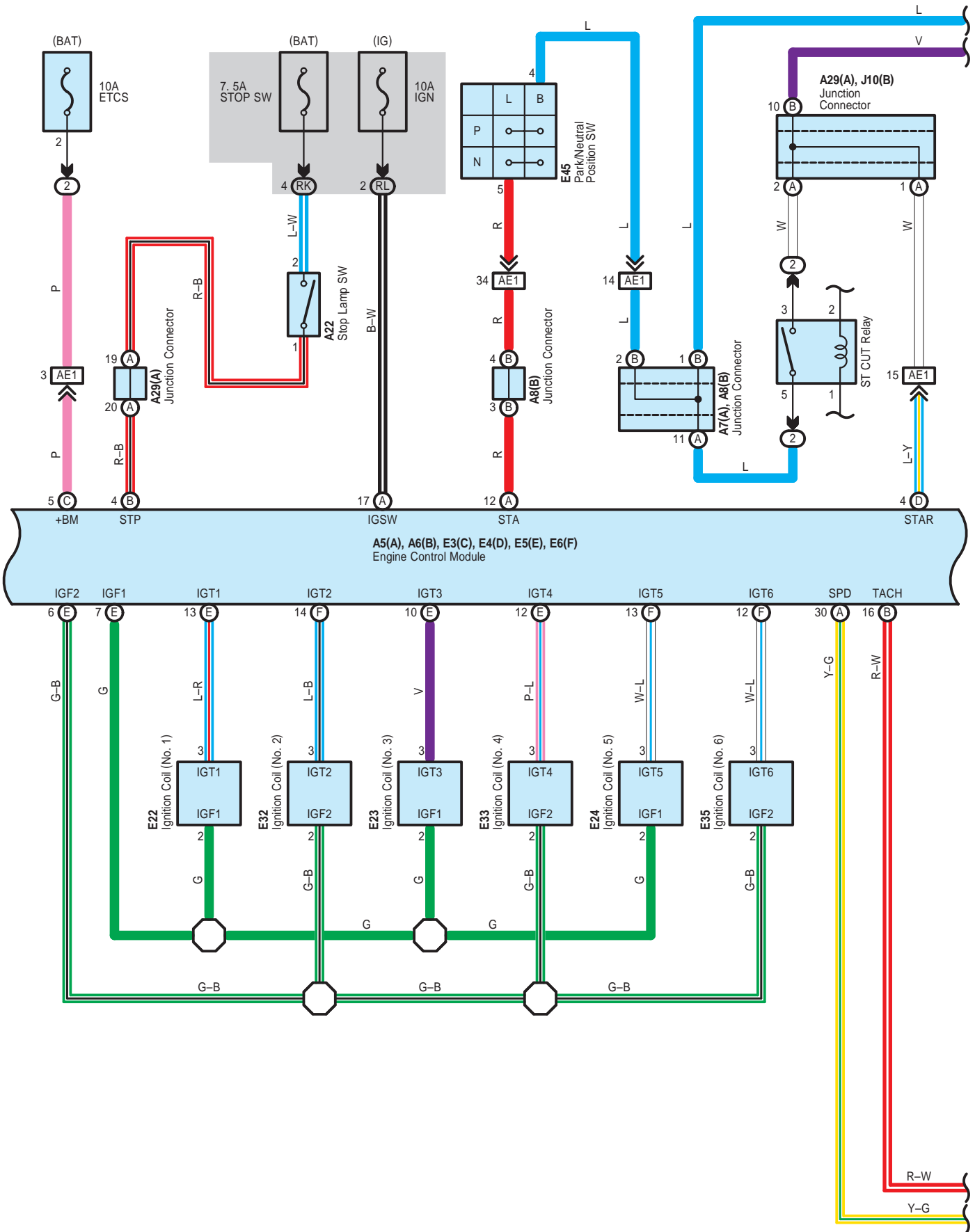

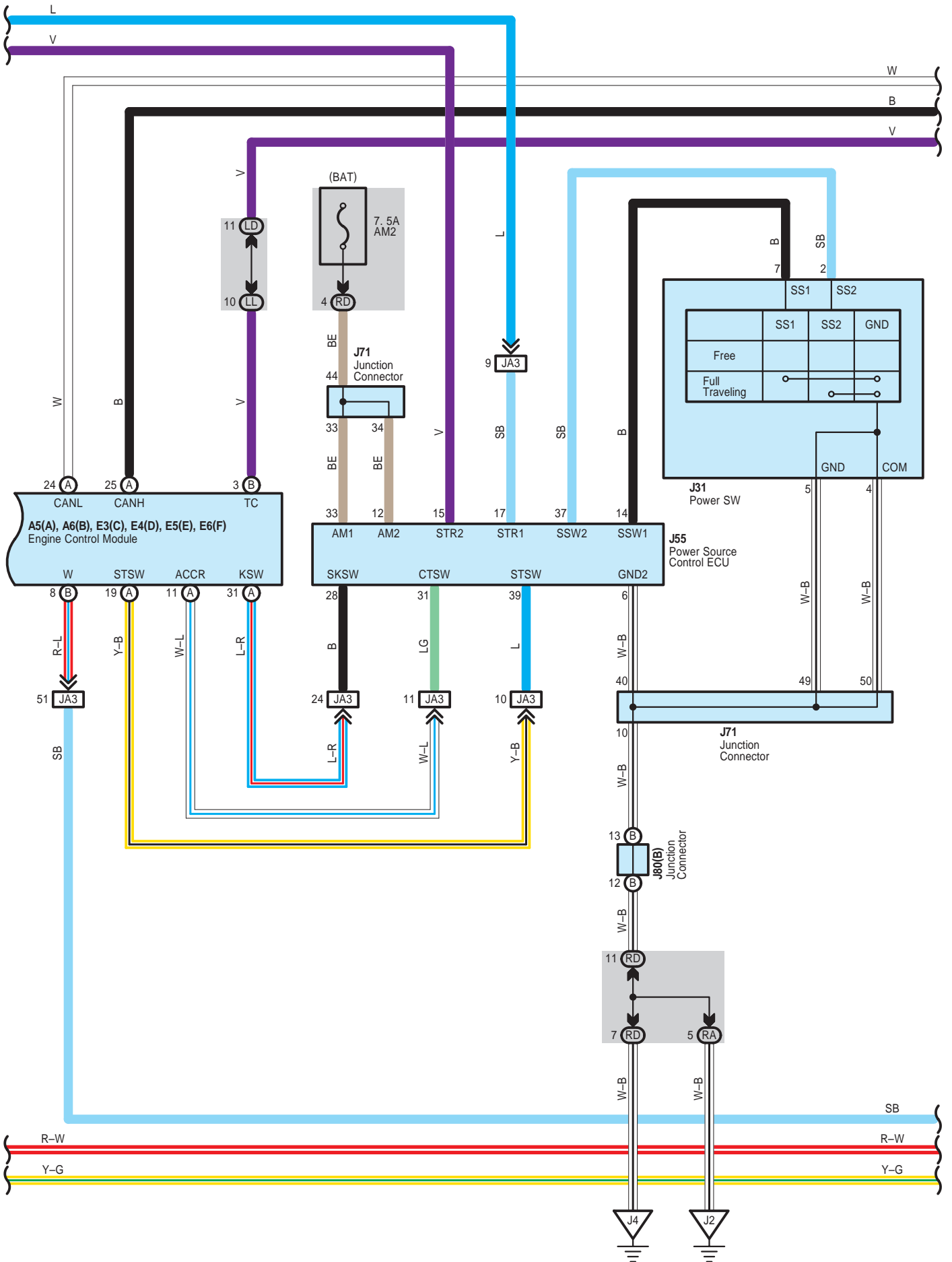

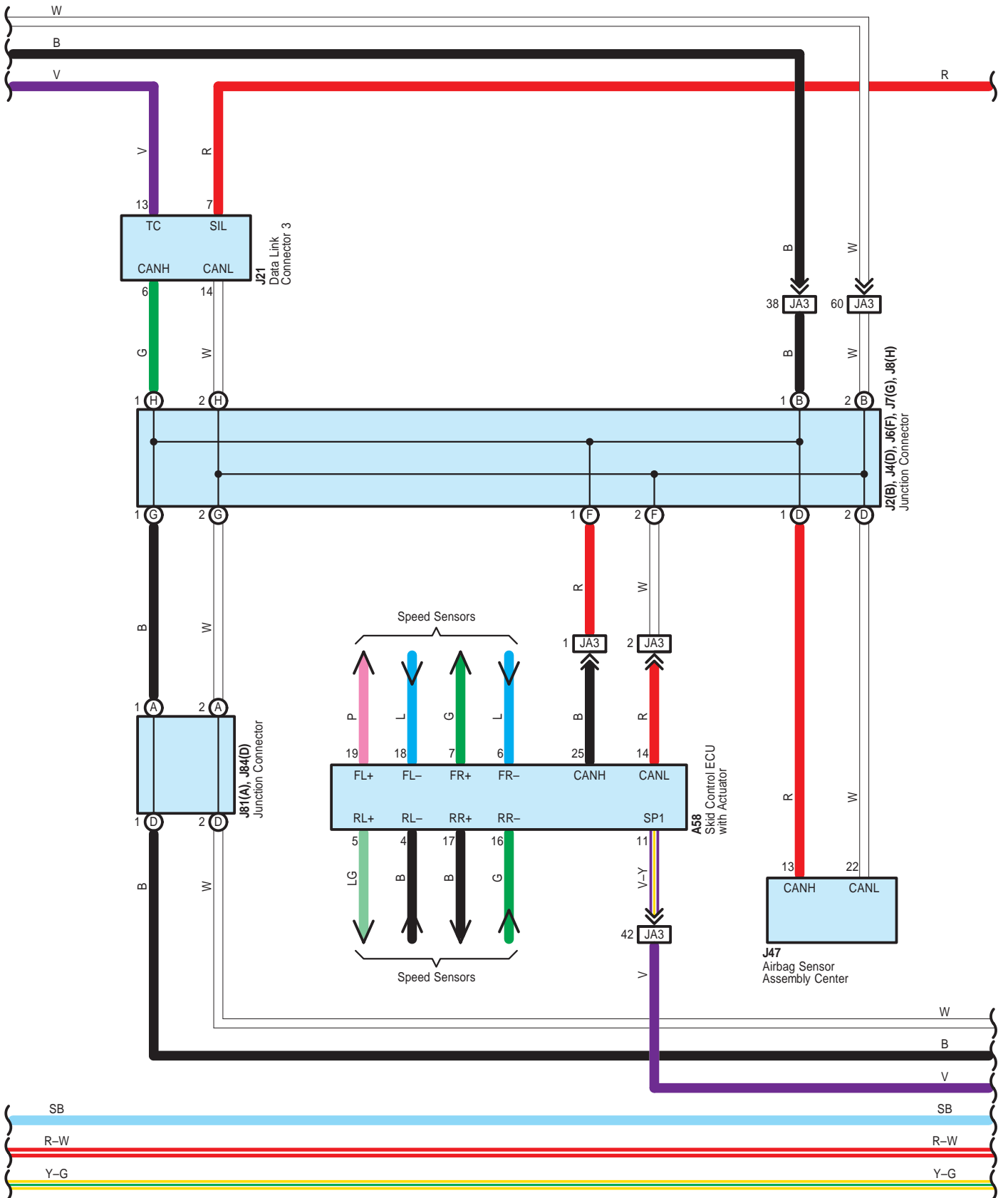

* 3 : w/ Adaptive Front-Lighting System
 * 4 : w/o Adaptive Front-Lighting System

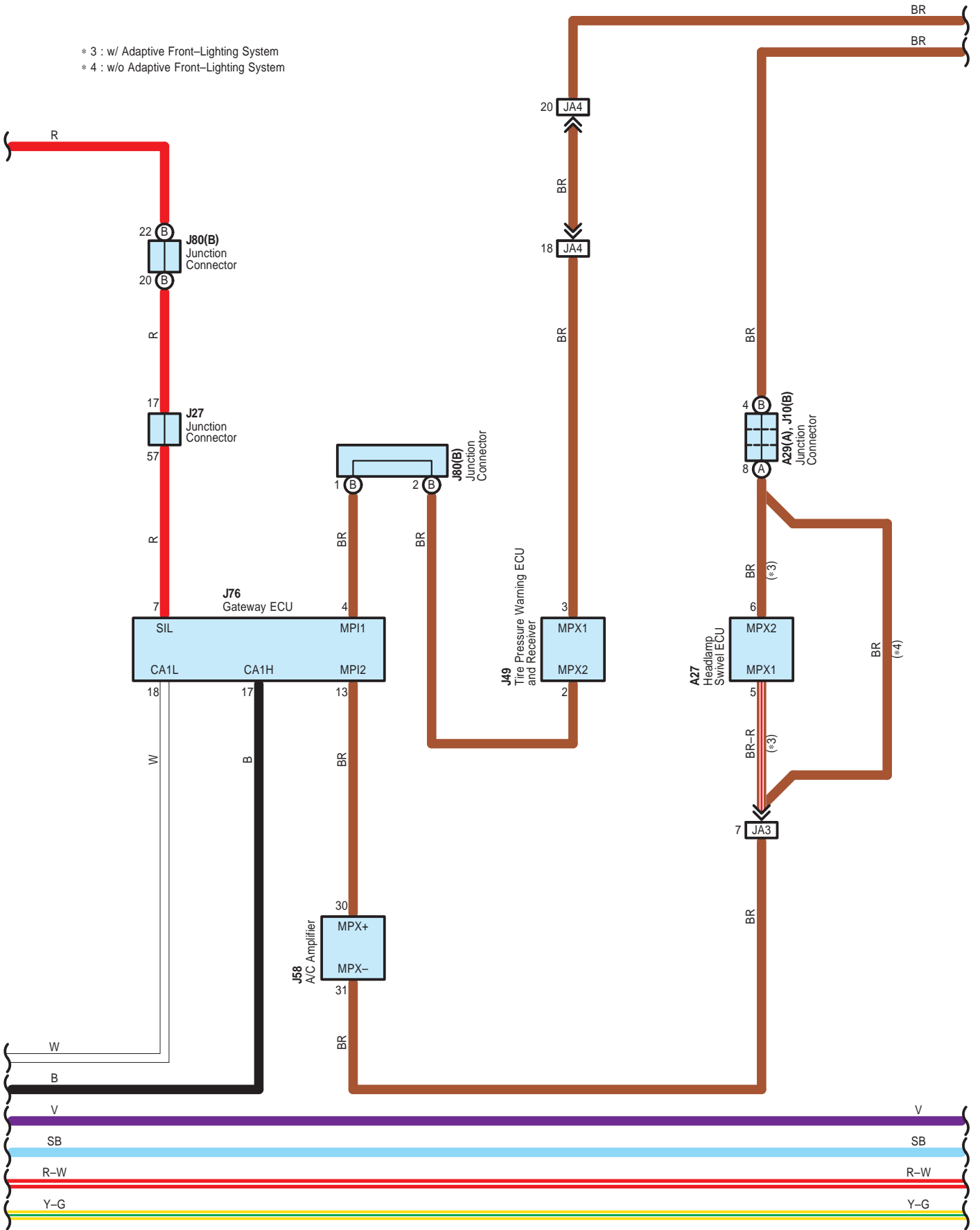

Engine Control <2GR-FSE>

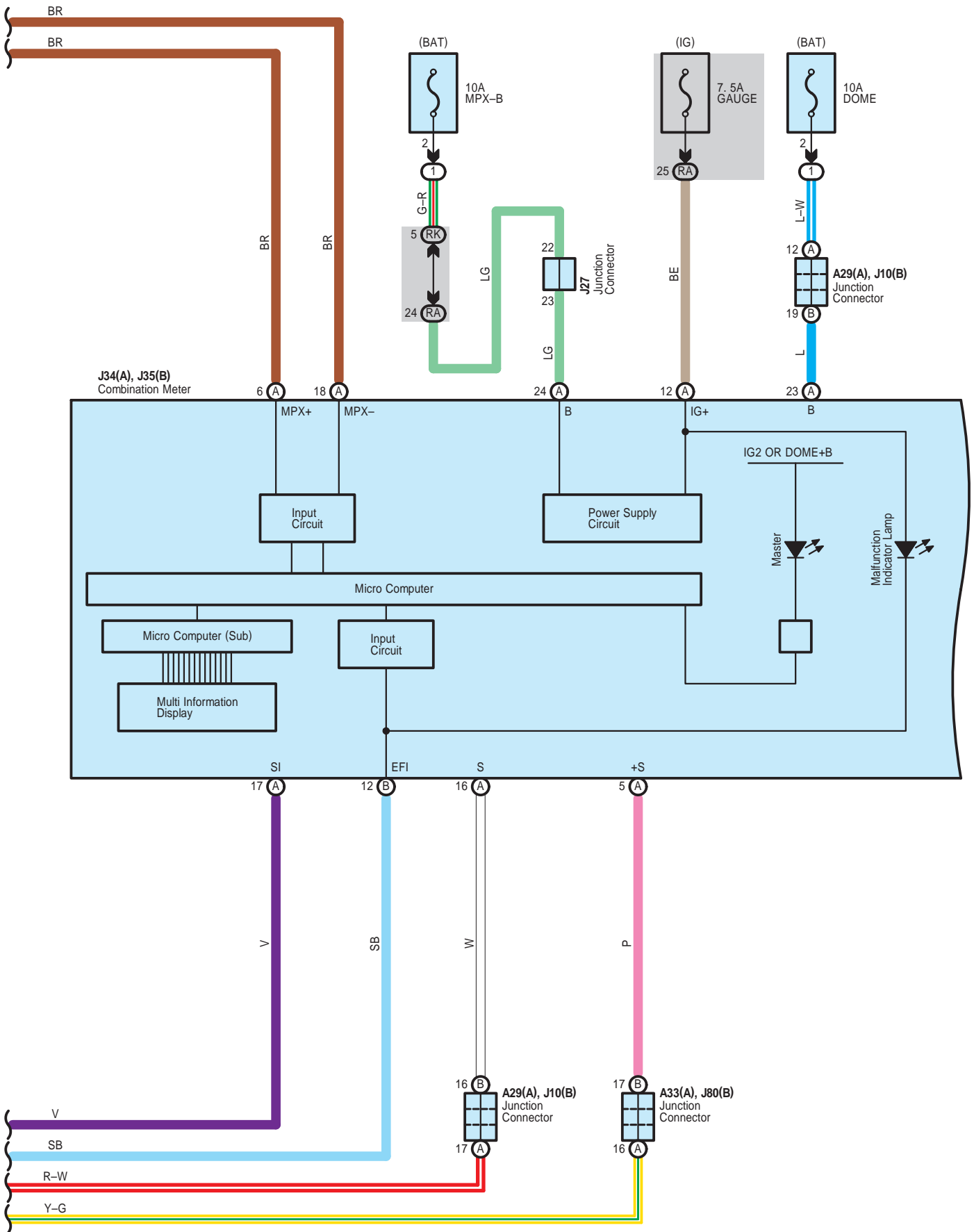

J34(A), J35(B)
Combination Meter

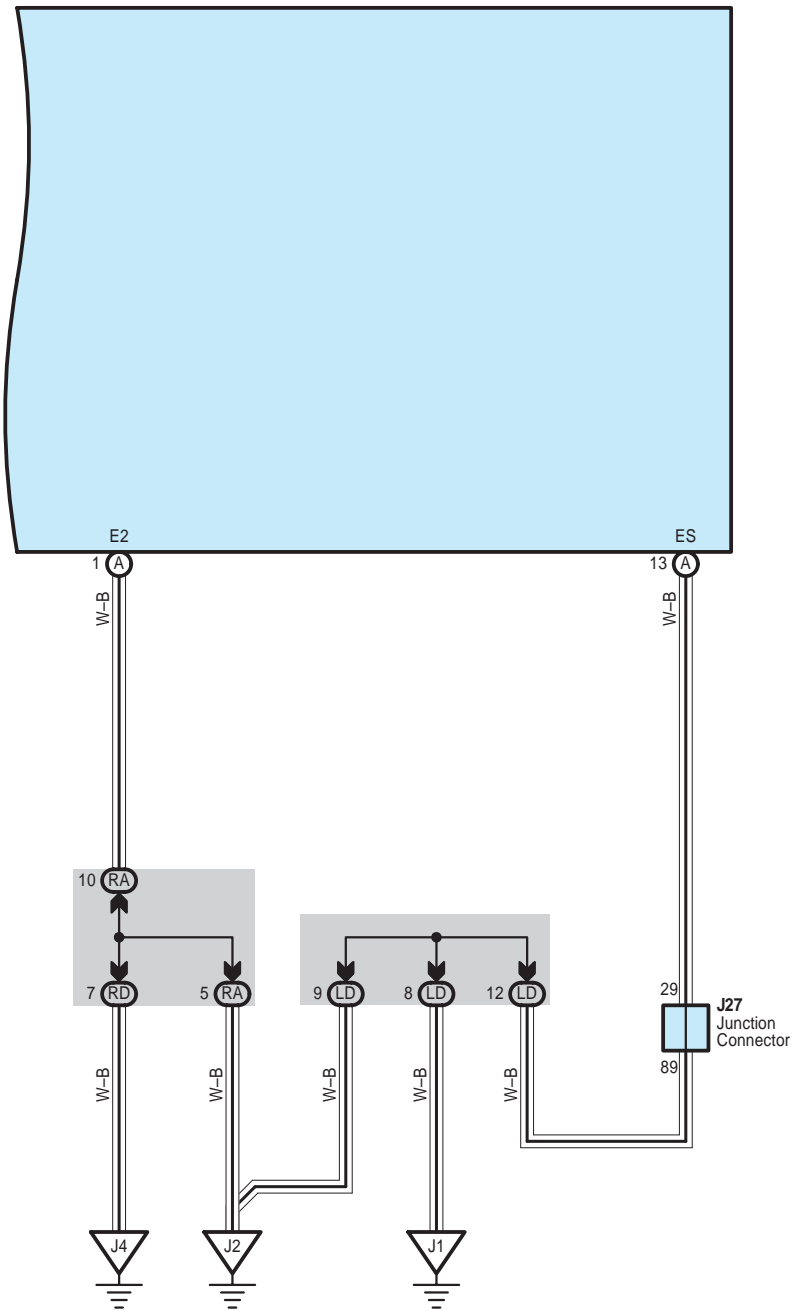

A 5
White

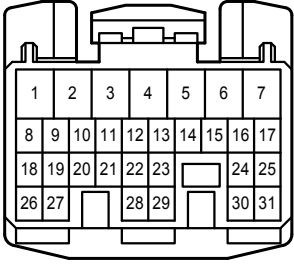

A 6
White

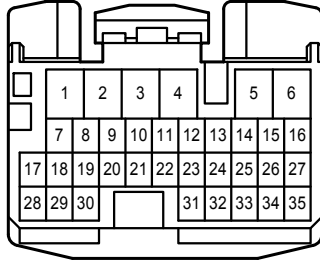

A 7
Blue

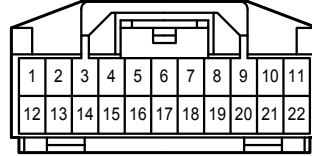

A 8
Blue

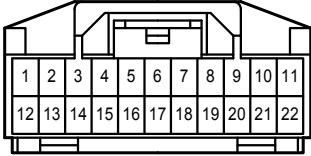

A 9
White

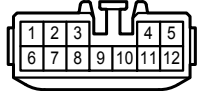

A 10
Gray

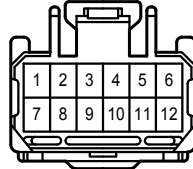

A 22
Green

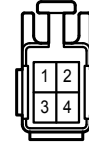

A 26
Black

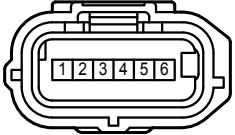

A 27
White

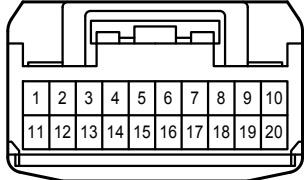

A 29
Blue

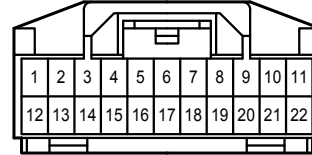

A 33
Blue

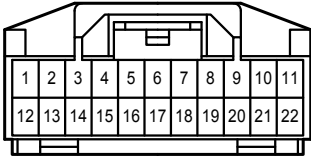

A 40
Black



A 58
Black

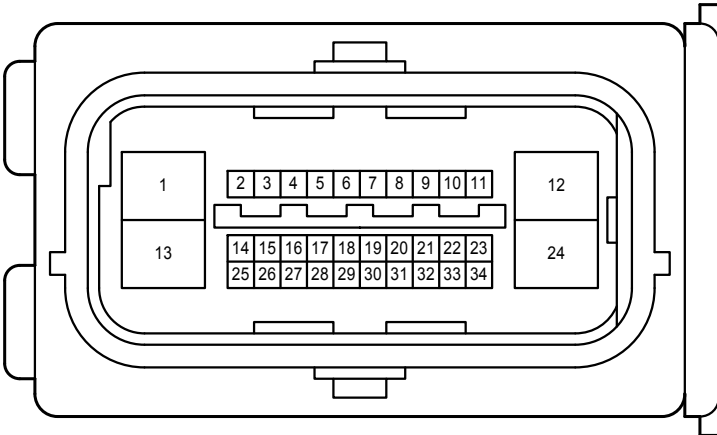

B 5
Black



E 1
Gray

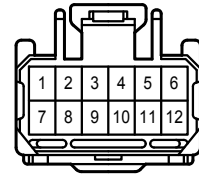

Engine Control <2GR-FSE>

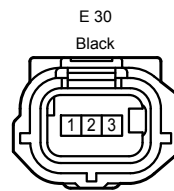
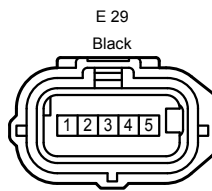
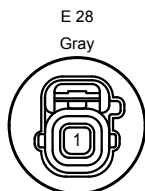
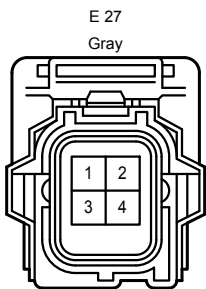
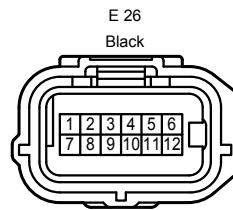
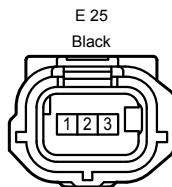
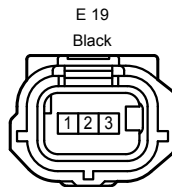
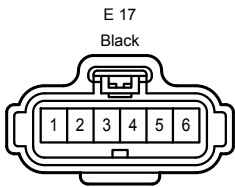
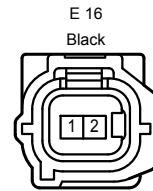
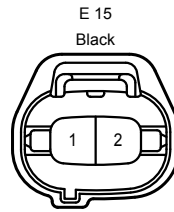
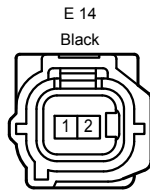
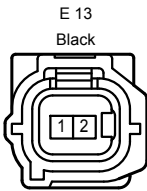
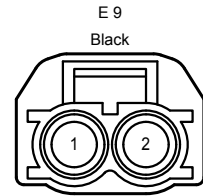
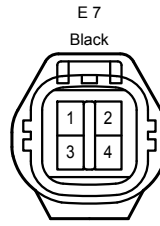
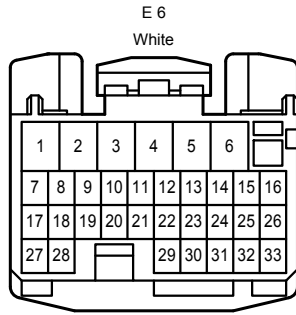
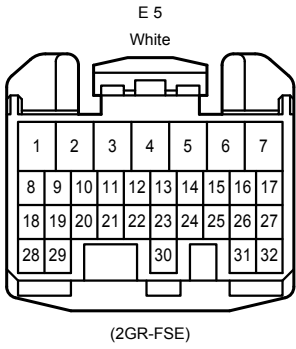
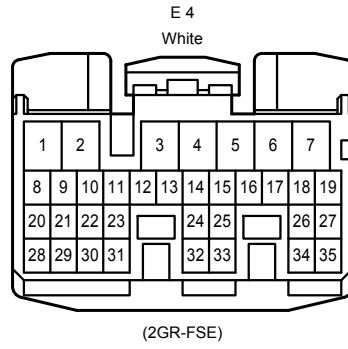
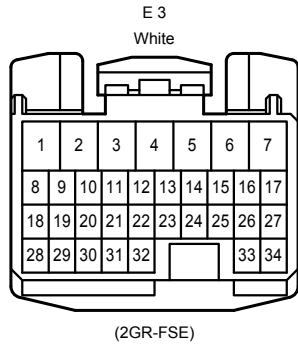
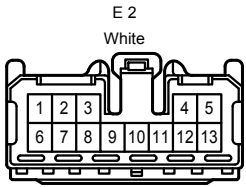

Engine Control <2GR-FSE>

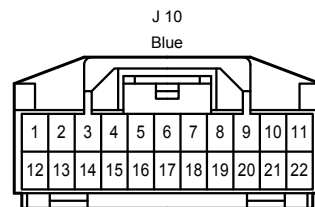
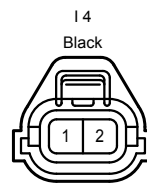
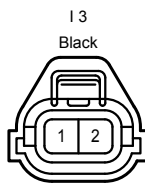
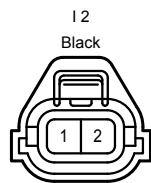
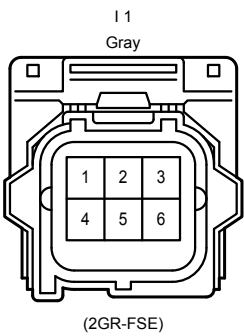
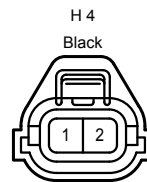
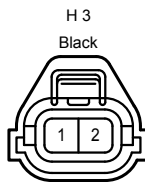
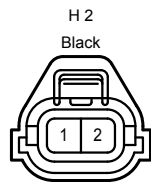
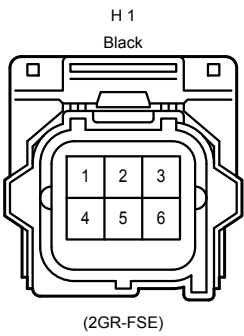
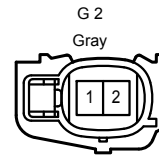
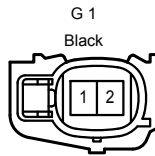
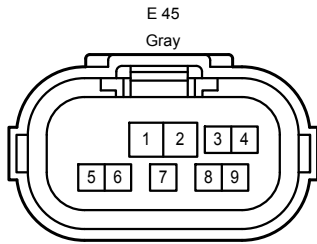
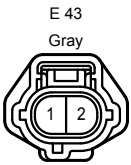
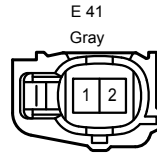
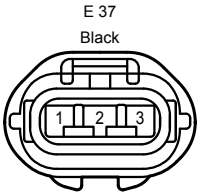
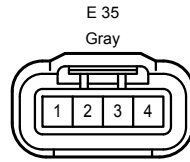
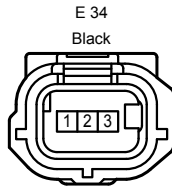
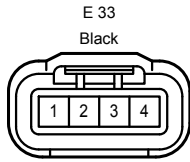

Engine Control <2GR-FSE>

J 21

White

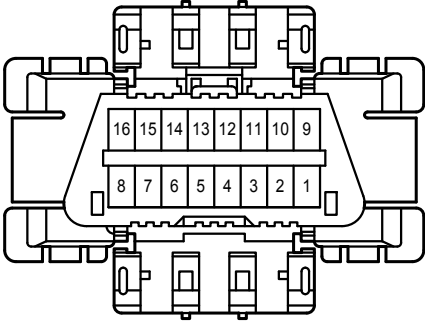

J 27

White

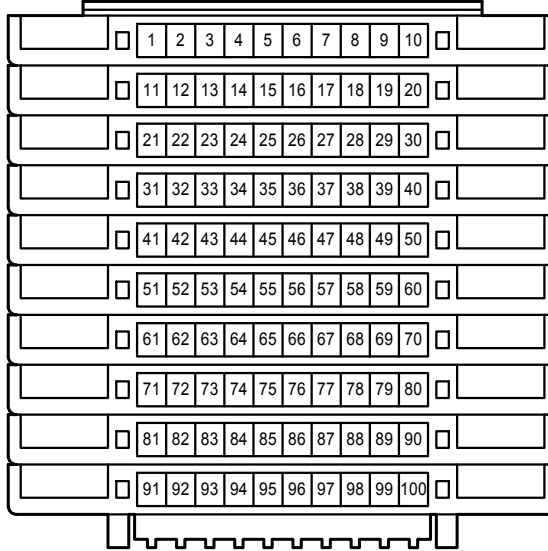

J 31

Black

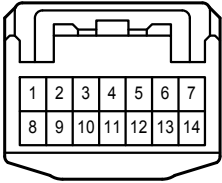

J 34

Black

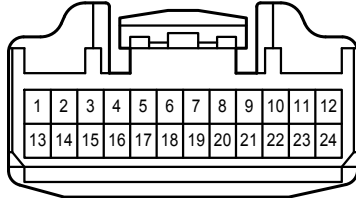

J 35

Black

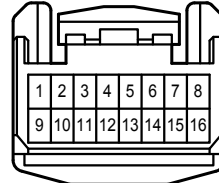

J 40

Dark Gray



J 47

Yellow

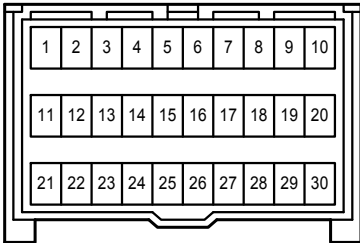

J 49

White

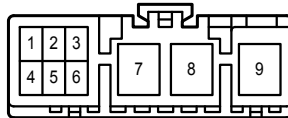

J 55

White

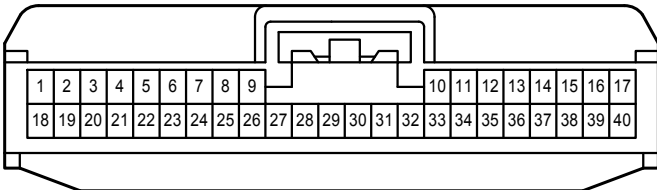

J 58

White

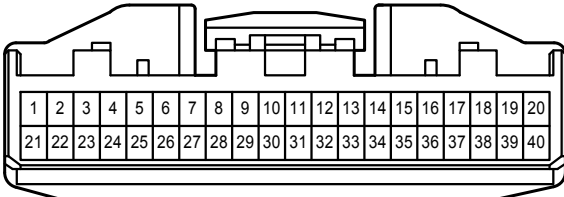

J 68

Dark Gray



J 69

White

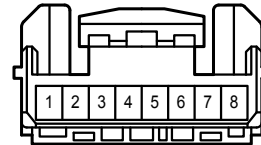

J 71
White

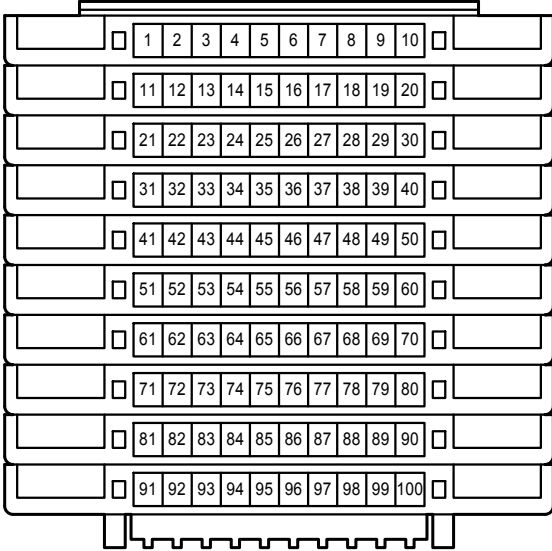

J 76
White

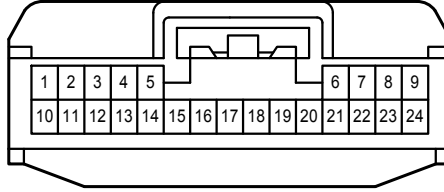

J 80
Blue

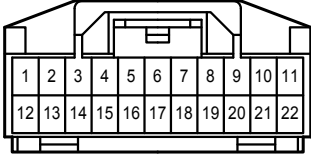

J 81
White

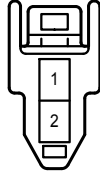

J 84
White

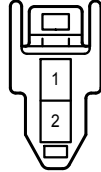

Q 14
White

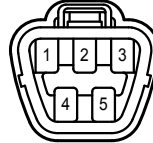

Q 49
Black



i 1
Black



i 2
Black



i 3
Black



2A
White

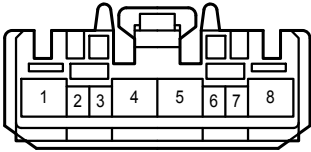

2B
White

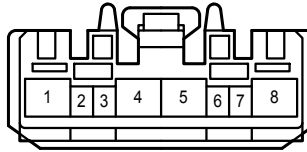

LD
White

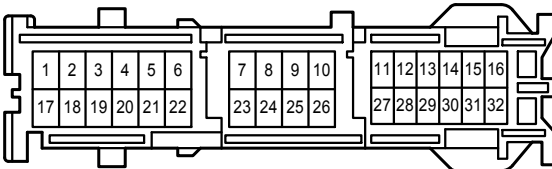

LL
Gray

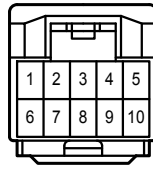

RA
White

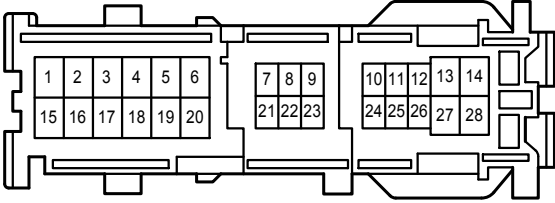

RD
White

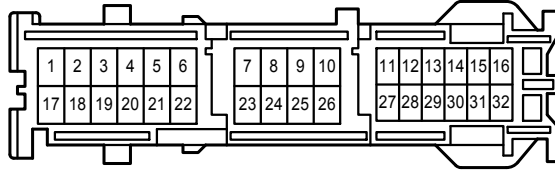

RK
Gray



RL
Gray

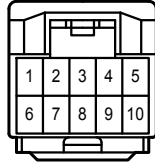

AE1
White

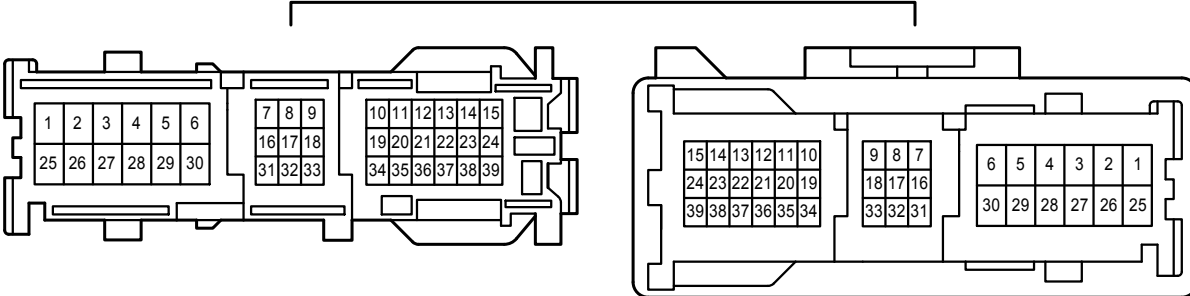

BA2
White

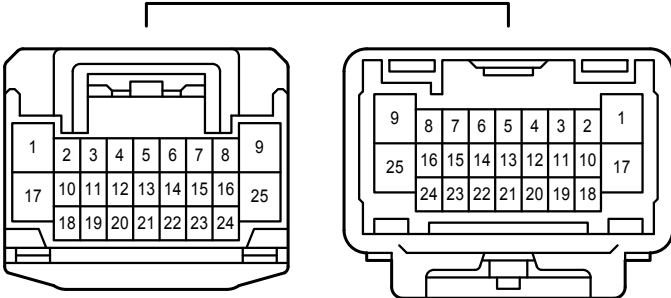

EG1
Gray

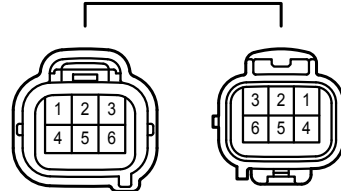

Ei1
Gray

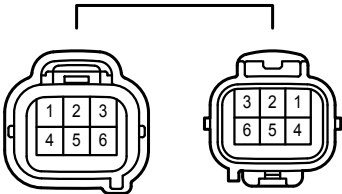

Engine Control <2GR-FSE>

JA3
White

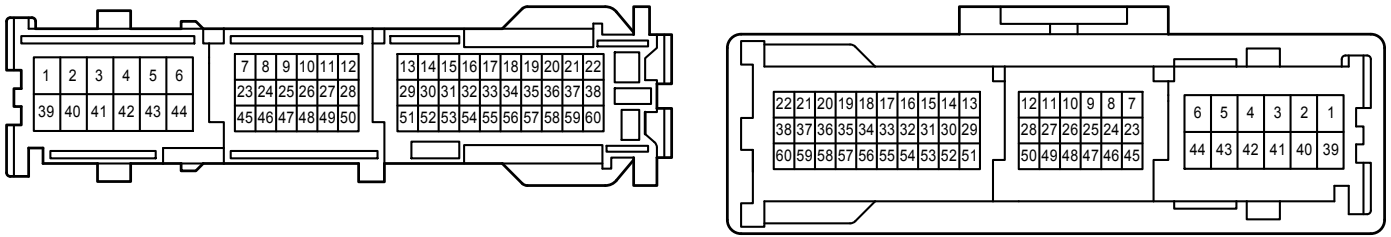

JA4
White

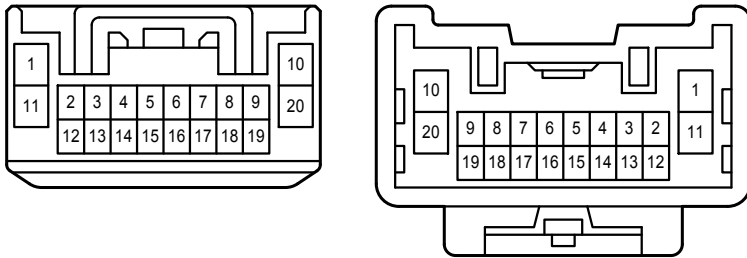

JQ1
White

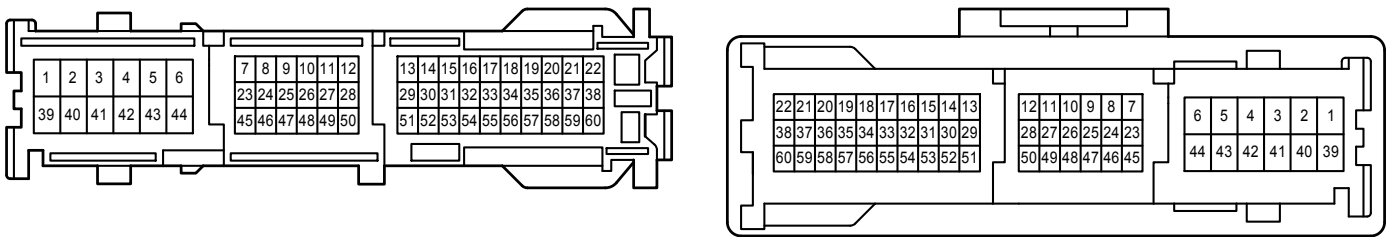

QA1
White

