

Engine Control <2GR-FE>

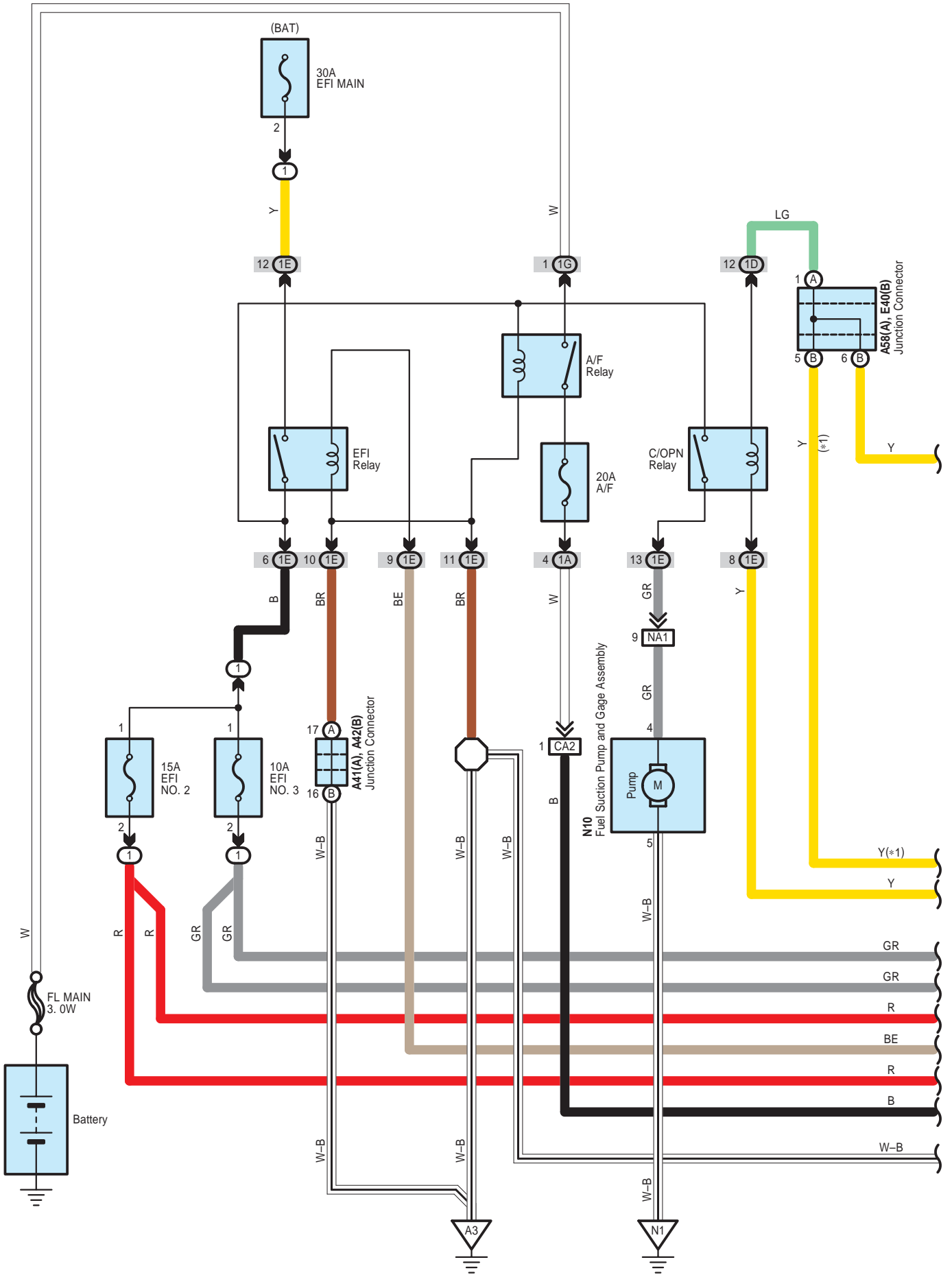

Engine Control <2GR-FE>

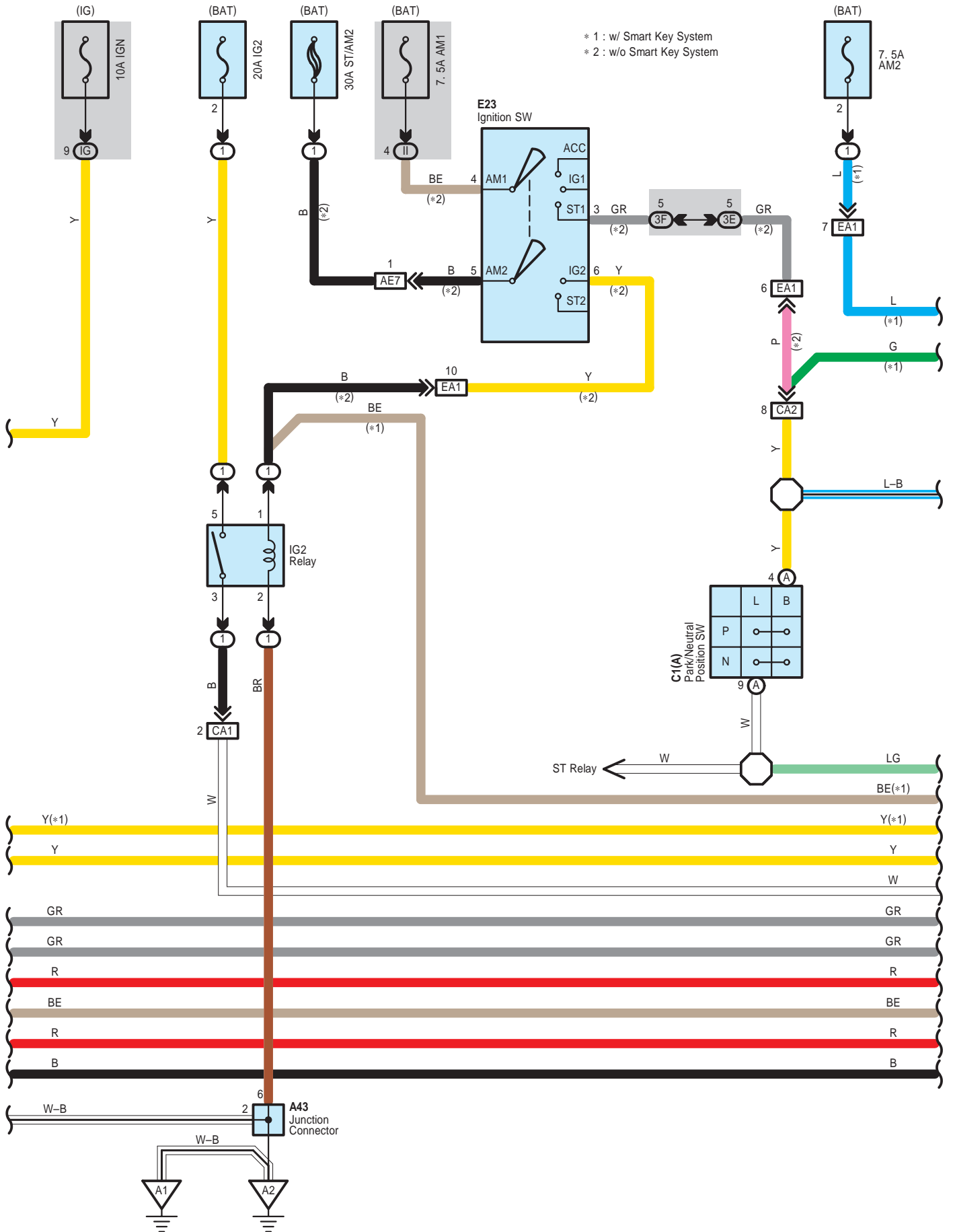

Engine Control <2GR-FE>

E6(A), E7(B), E8(C), E9(D)
Main Body ECU

* 1 : w/ Smart Key System

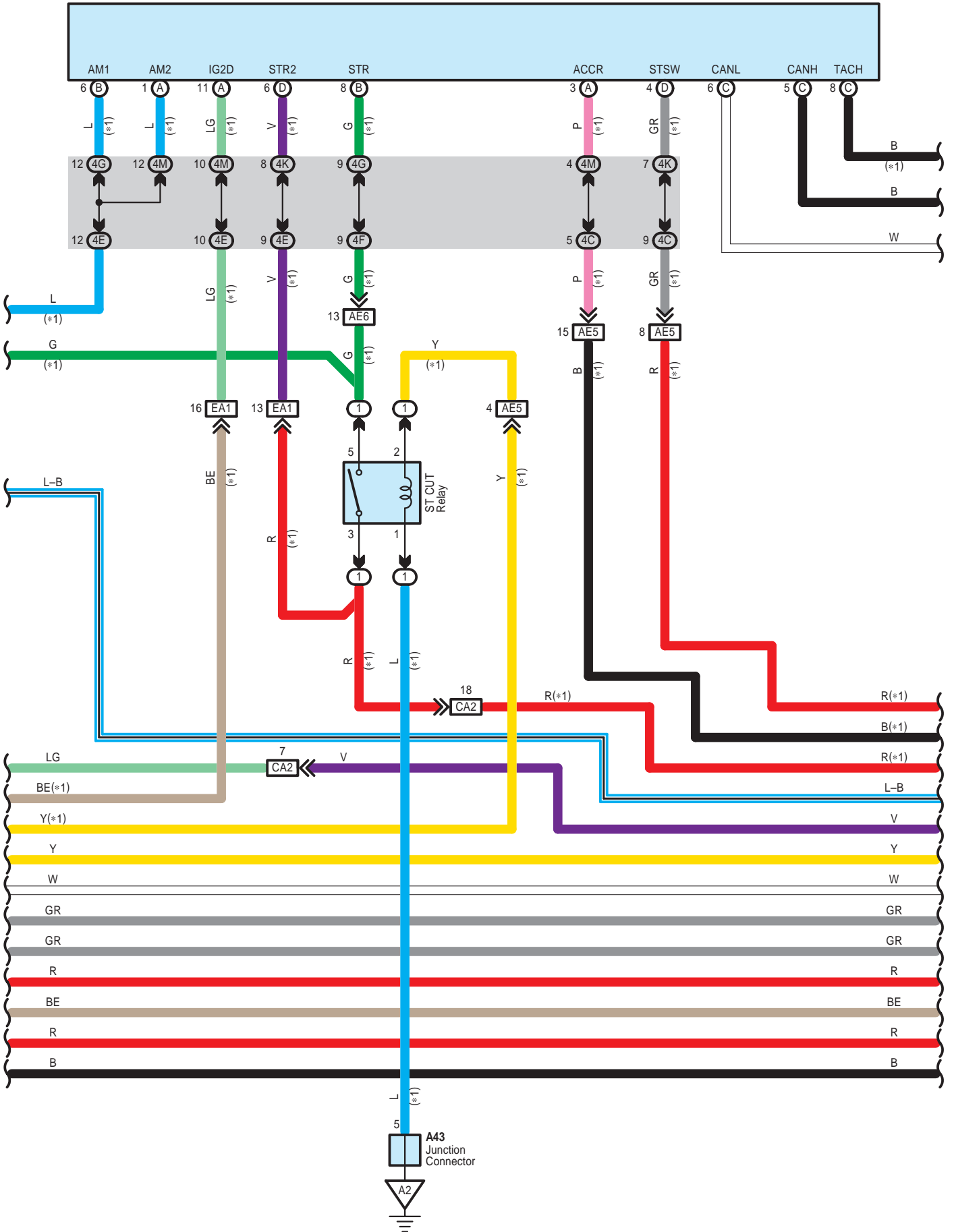

Engine Control <2GR-FE>

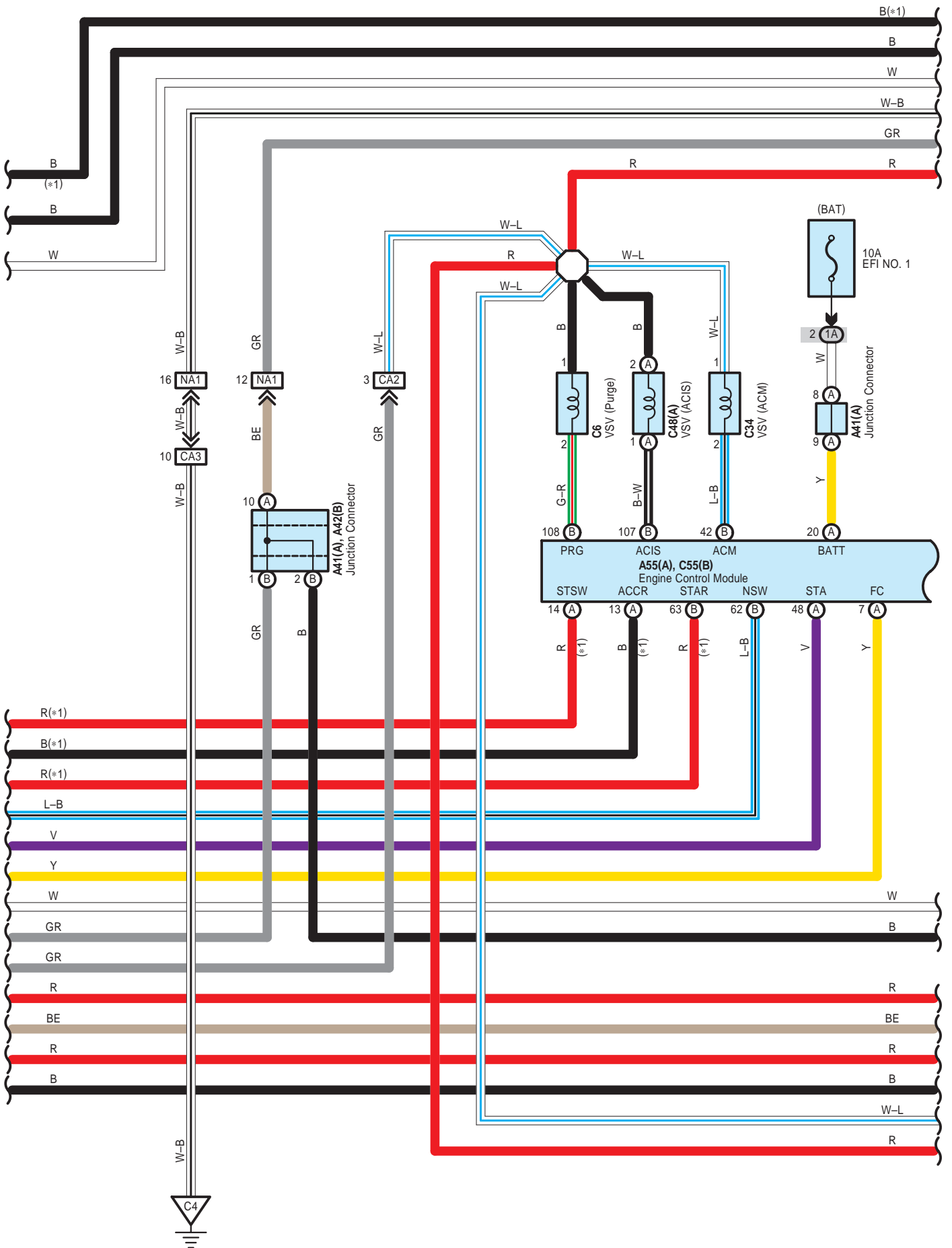

Engine Control <2GR-FE>

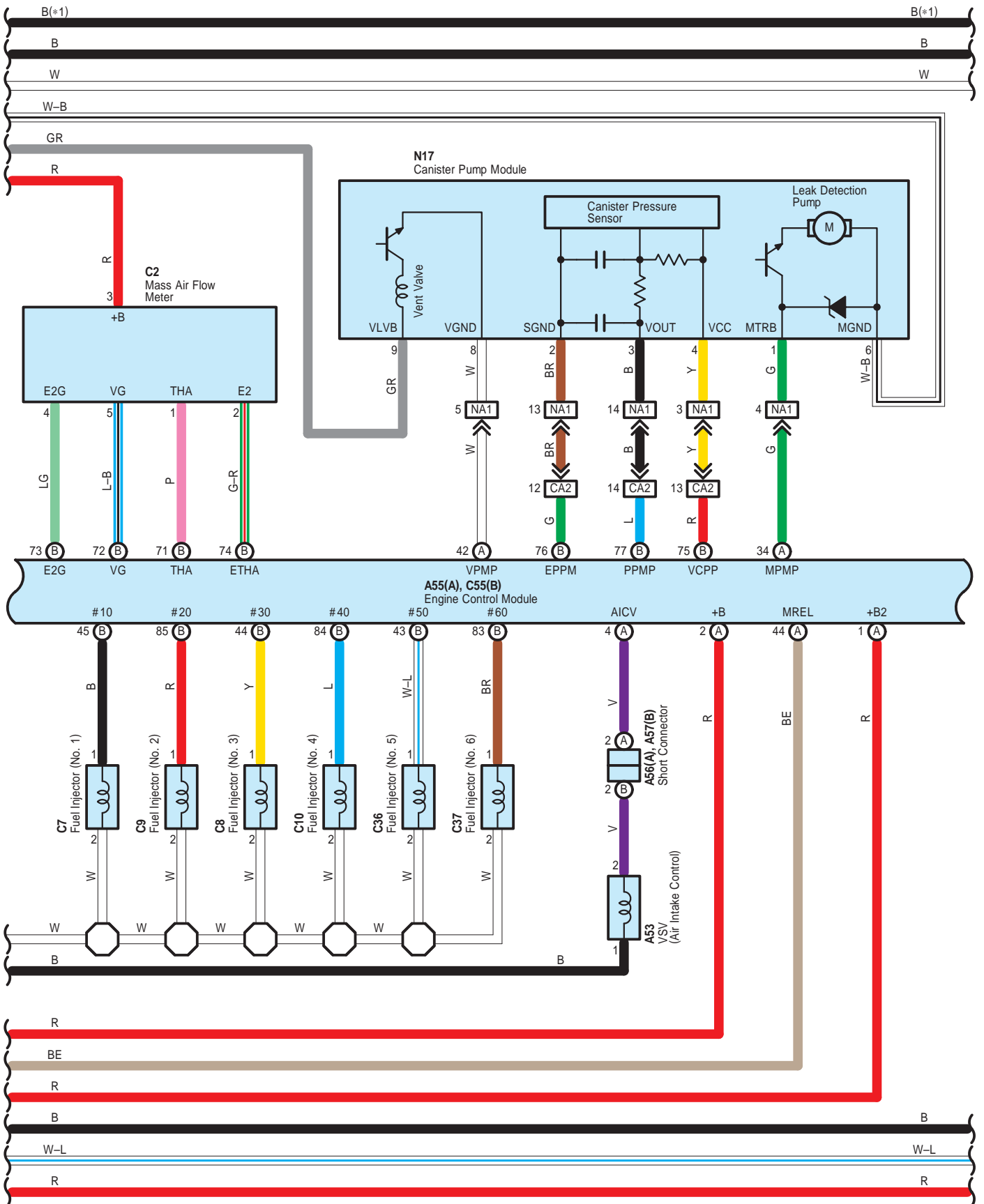

Engine Control <2GR-FE>

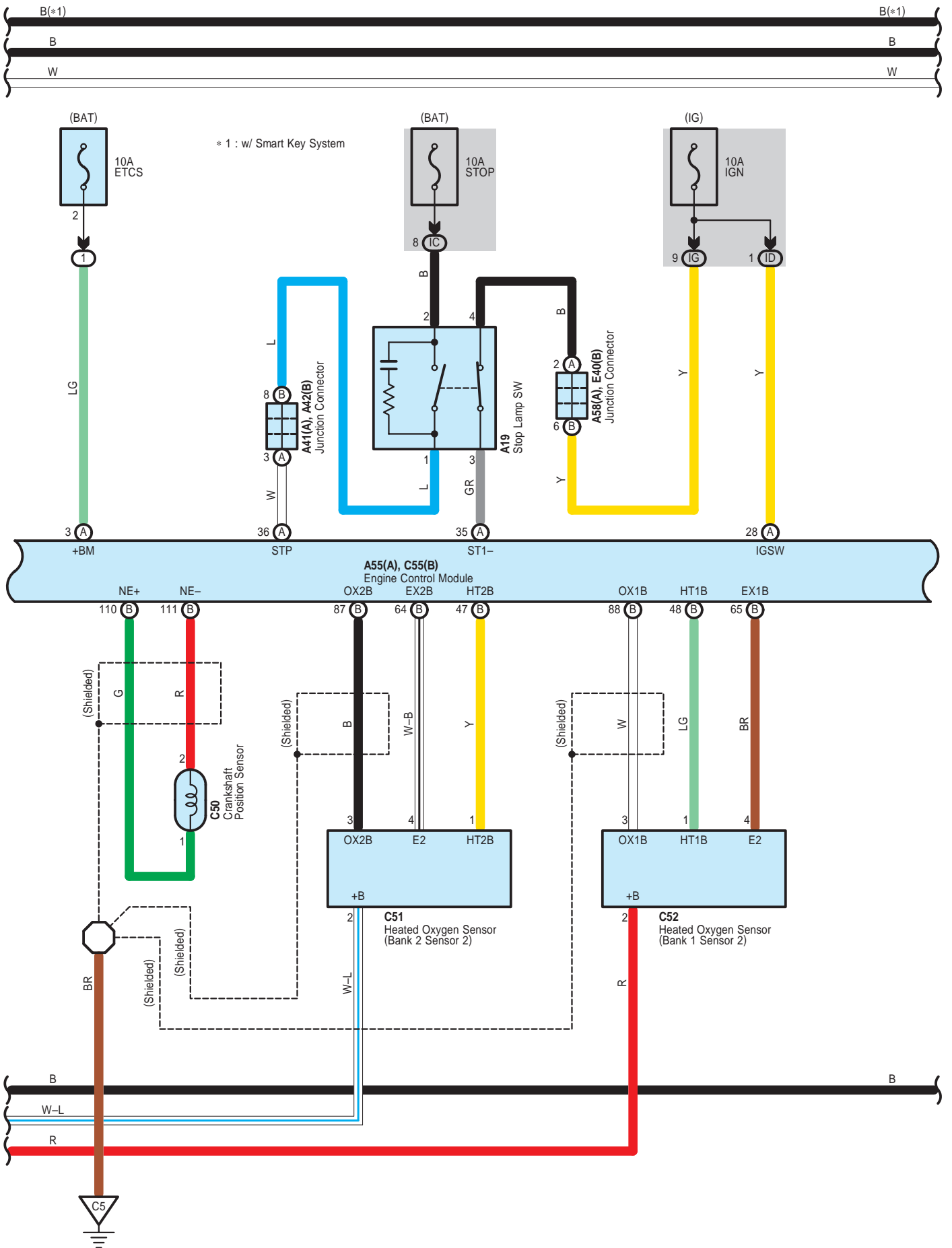

Engine Control <2GR-FE>

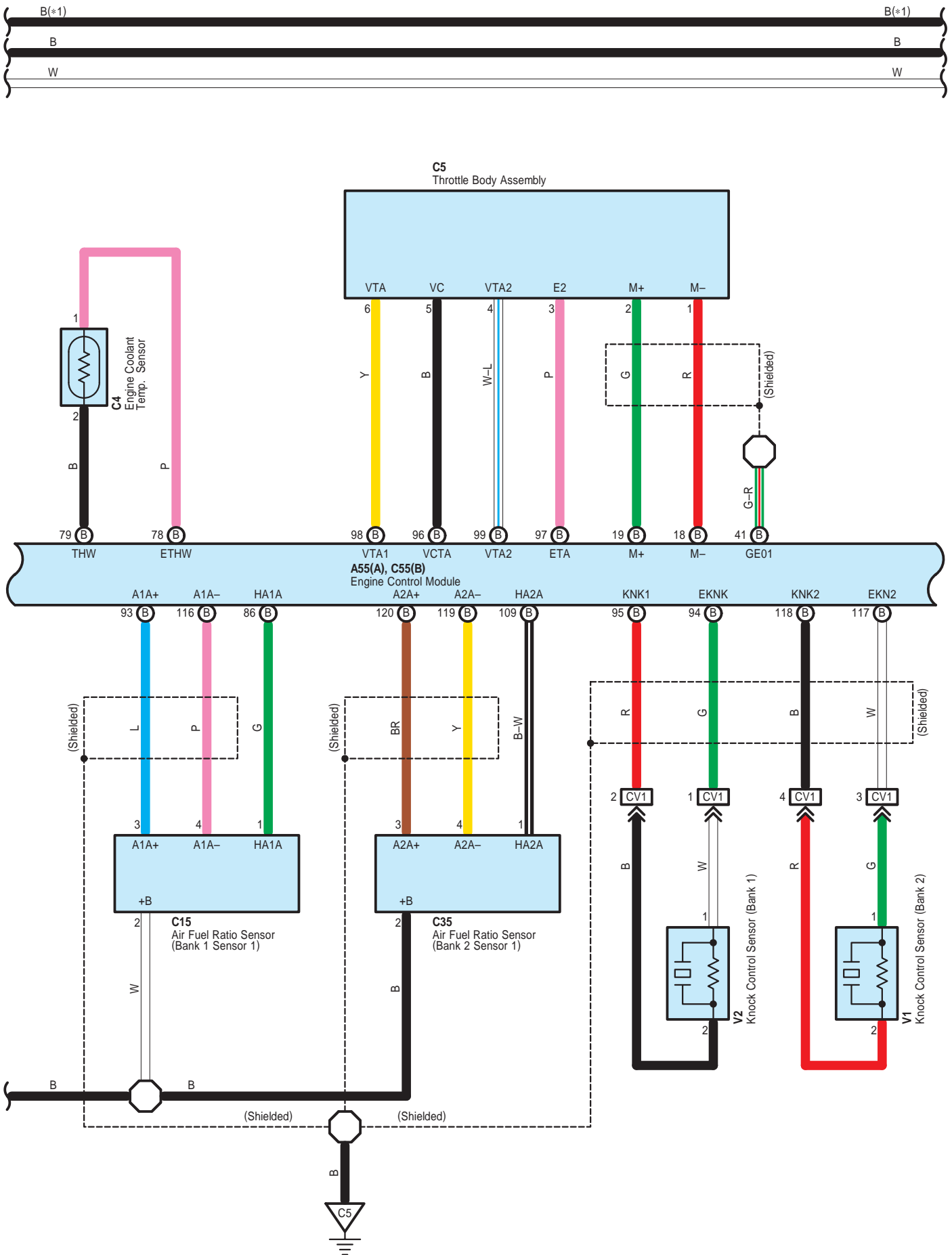

Engine Control <2GR-FE>

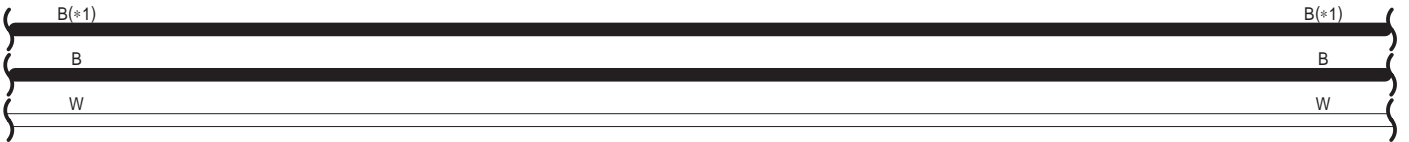

* 1 : w/ Smart Key System

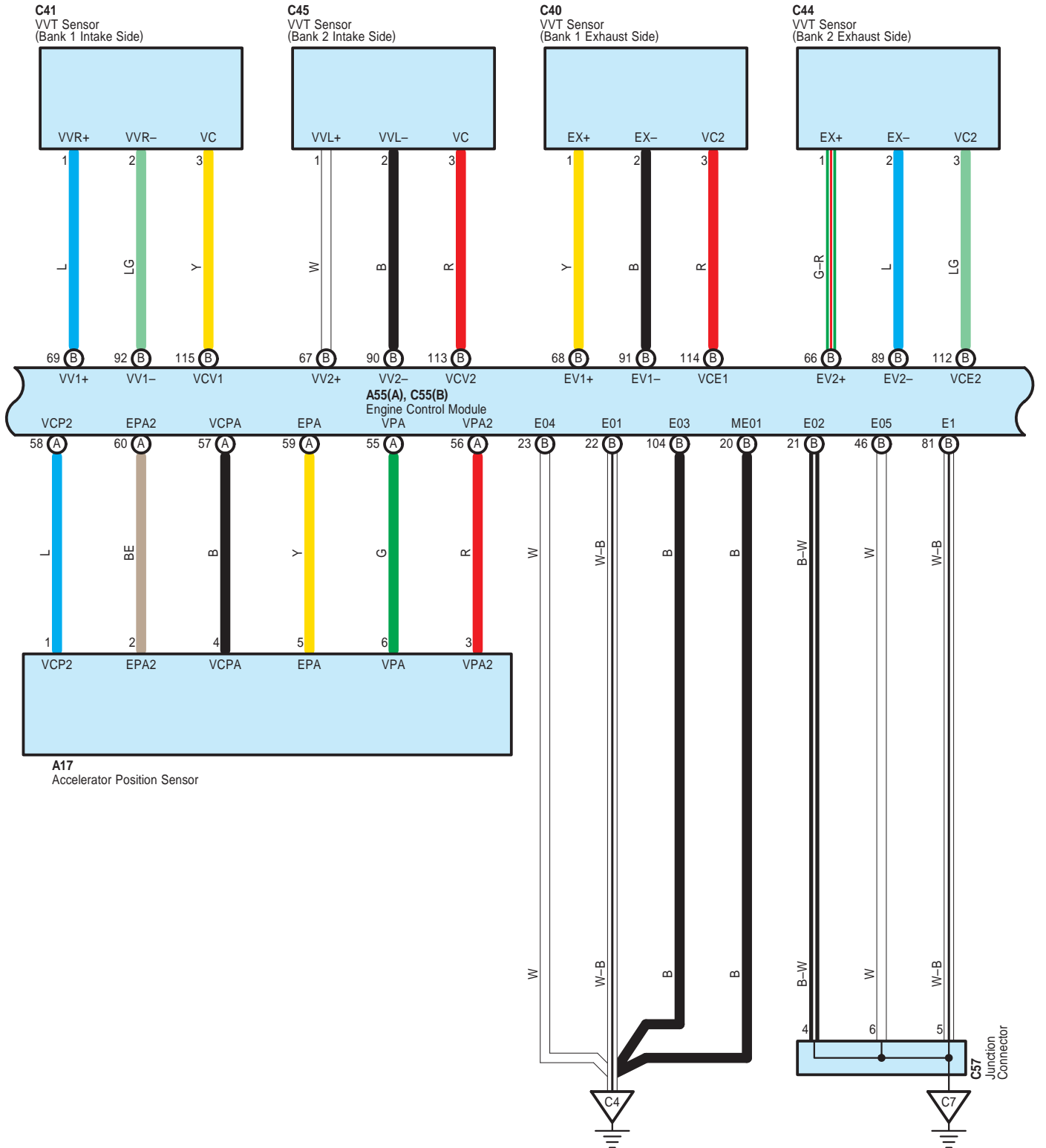

Engine Control <2GR-FE>

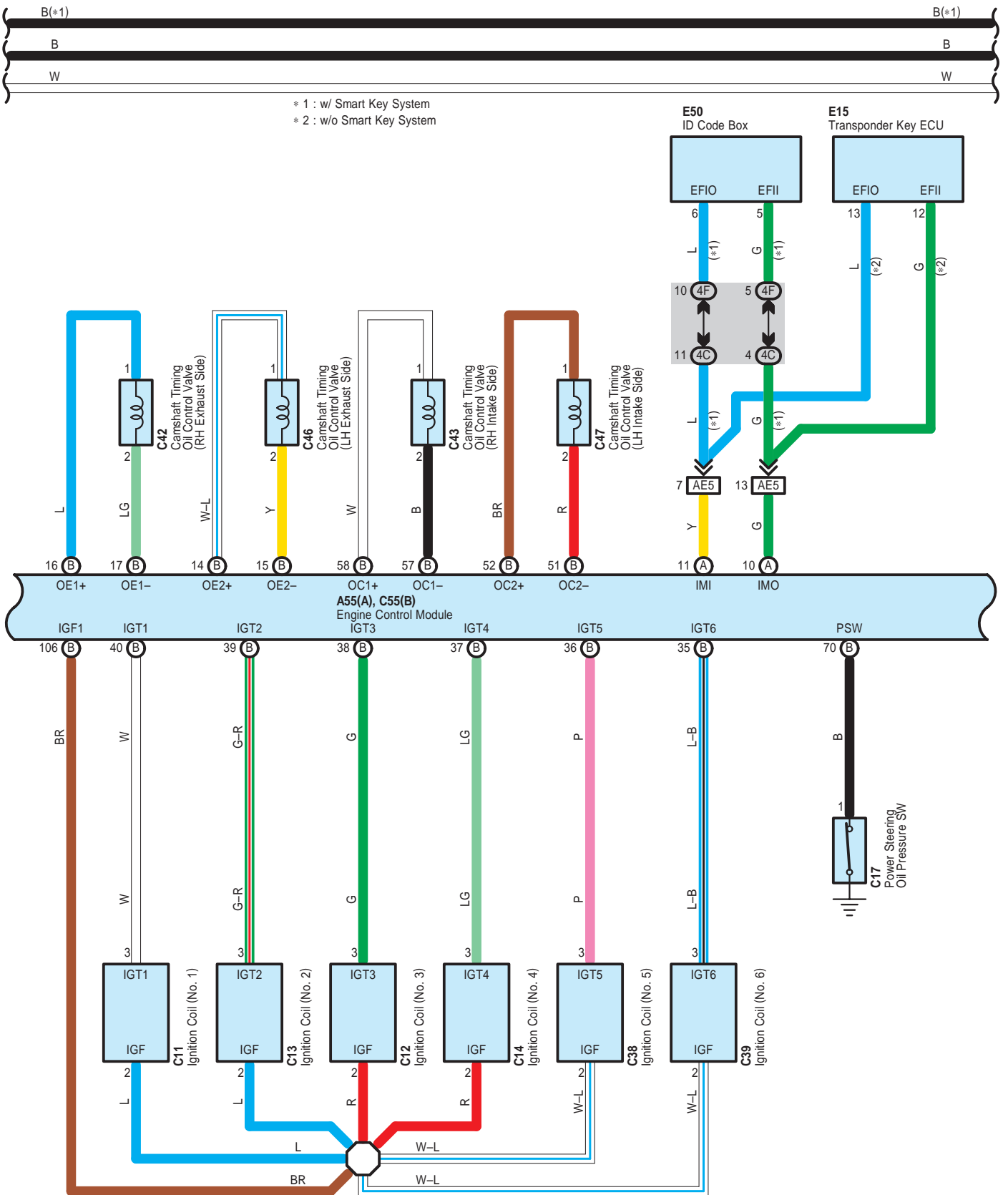

Engine Control <2GR-FE>

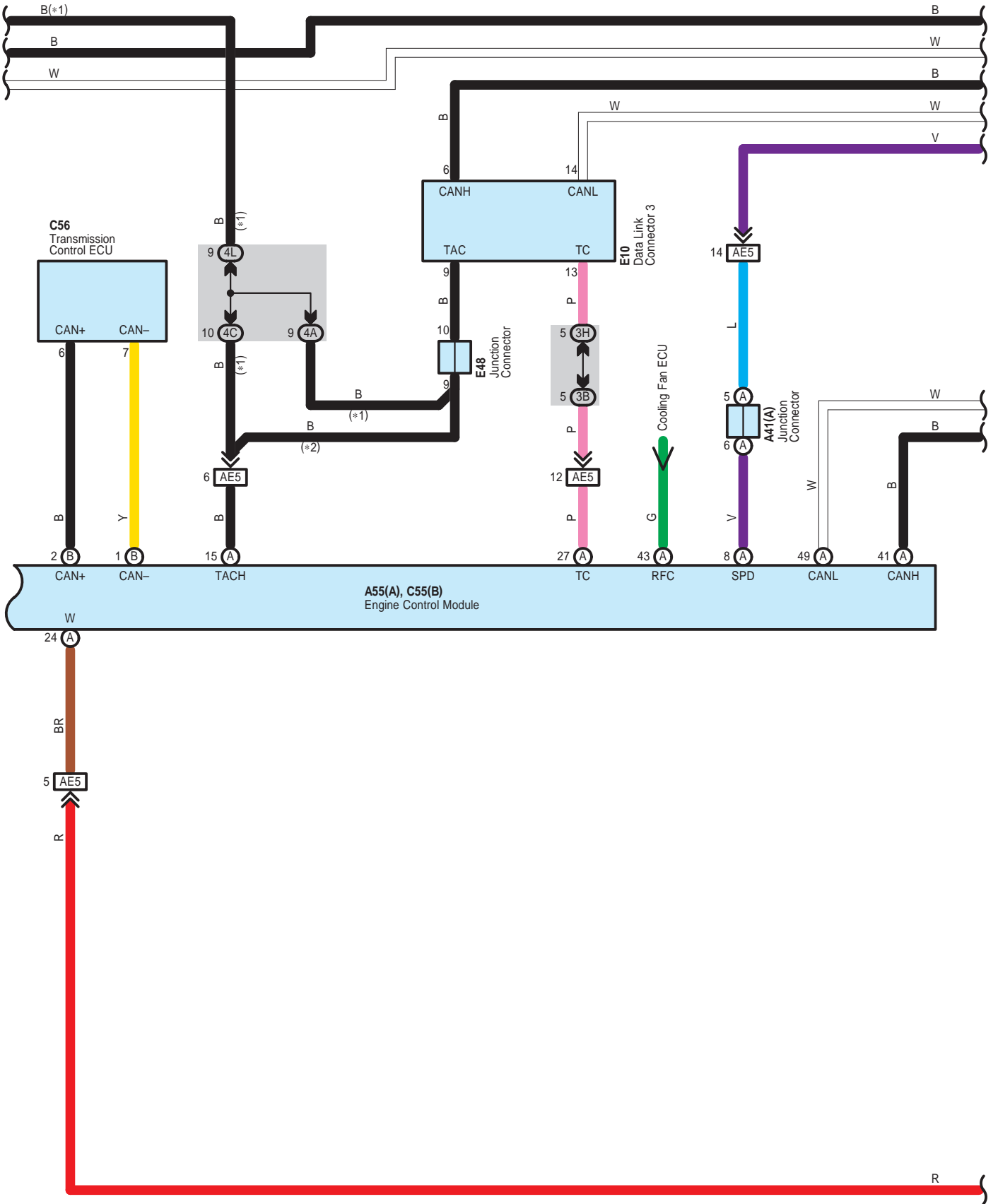

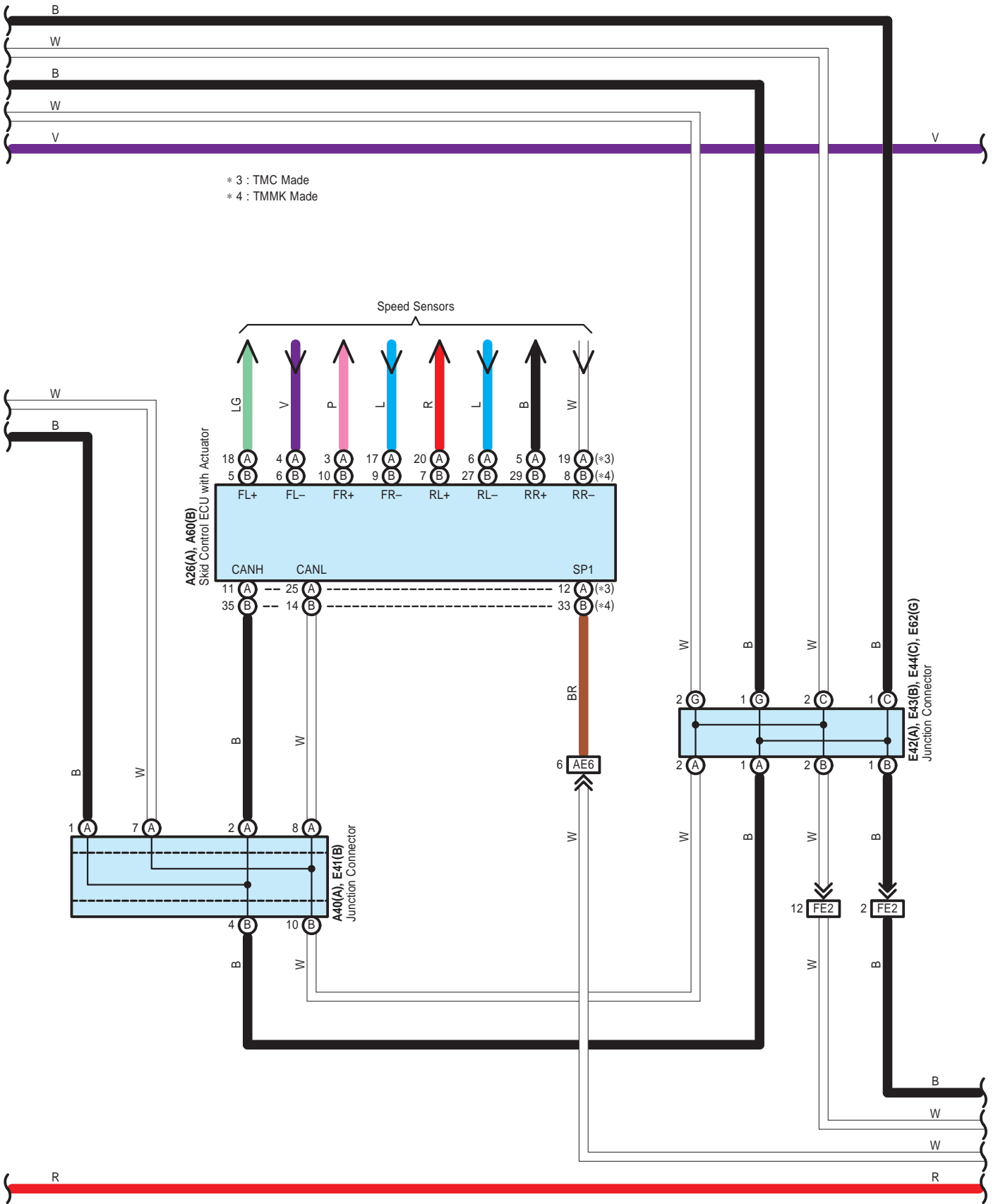

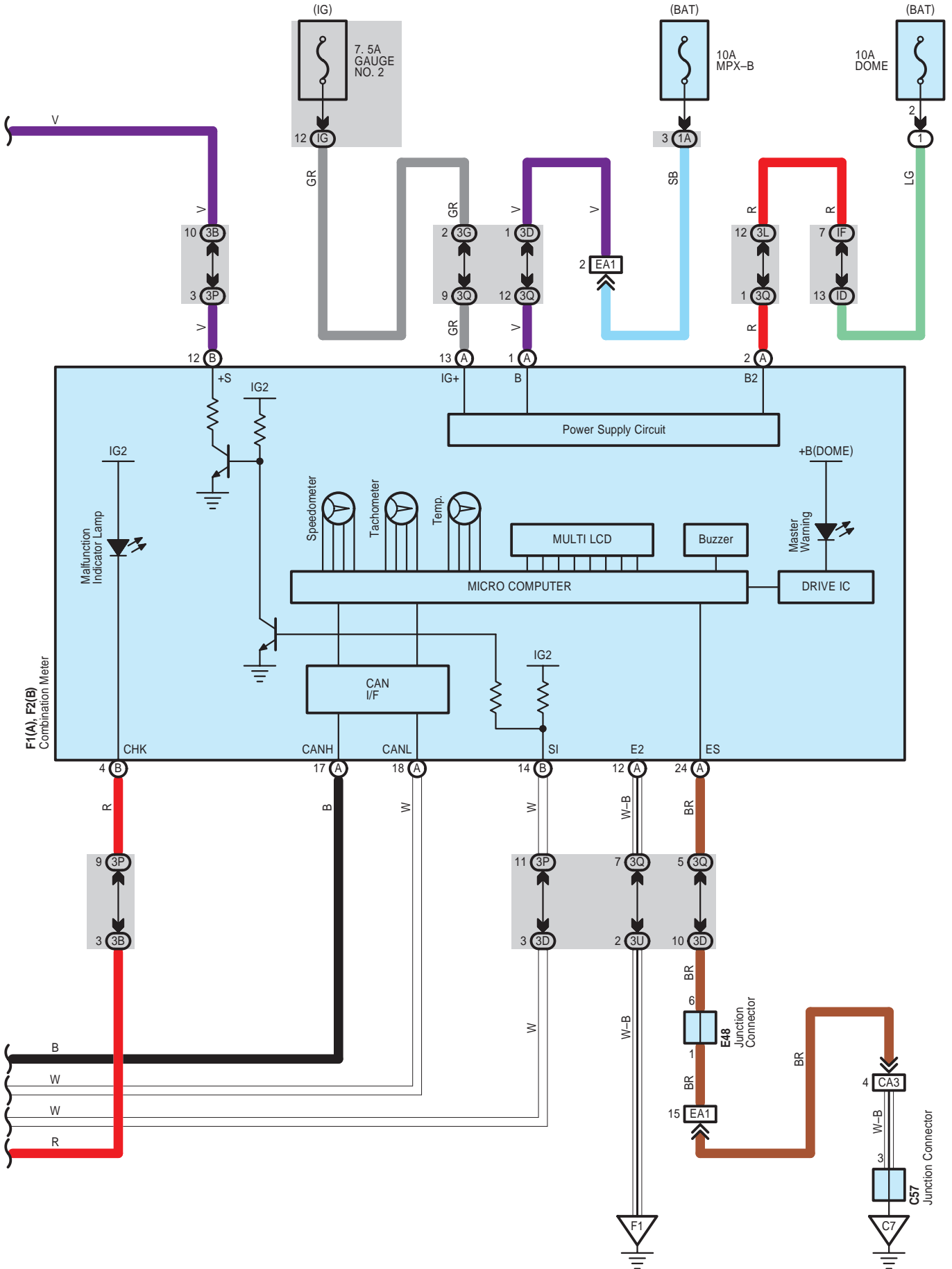

A 17
Black

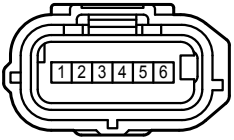

A 19
White

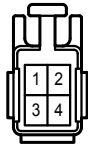

A 26
Black

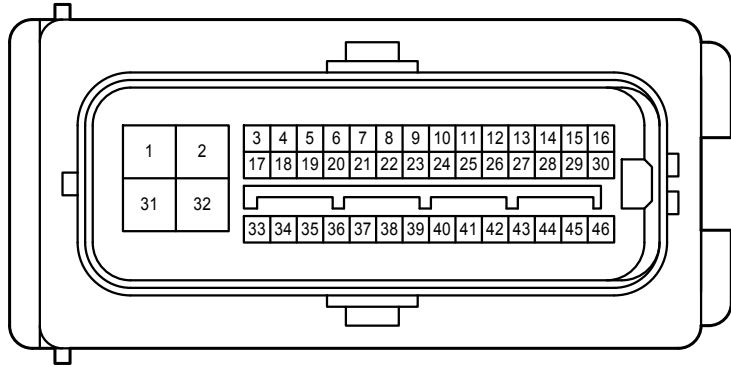

A 40
Blue

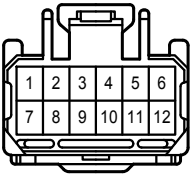

A 41
White

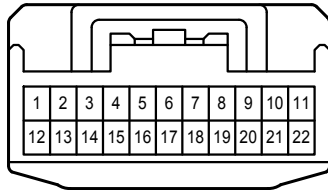

A 42
White

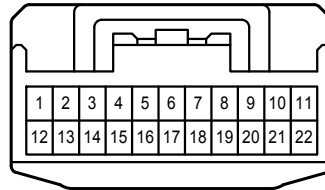

A 43
Gray

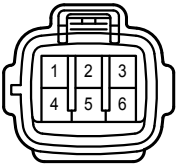

A 53
Black

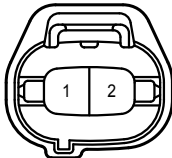

A 55
Black

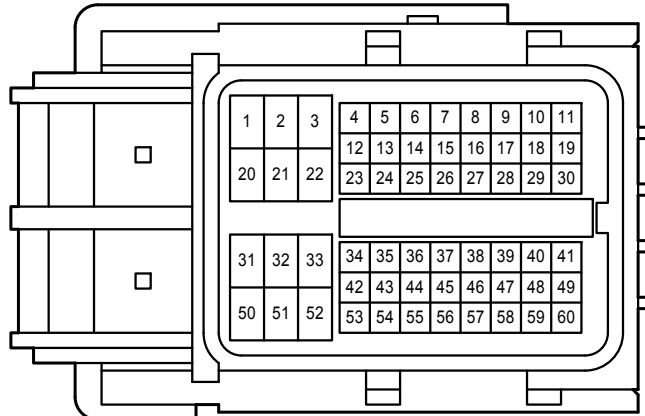

A 56
White

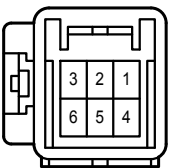

A 57
White

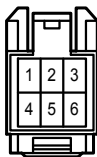

A 58
Black

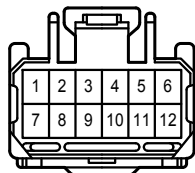

A 60
Black

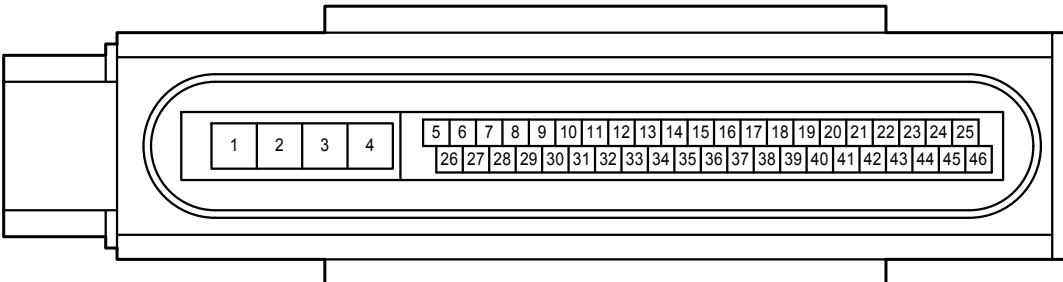

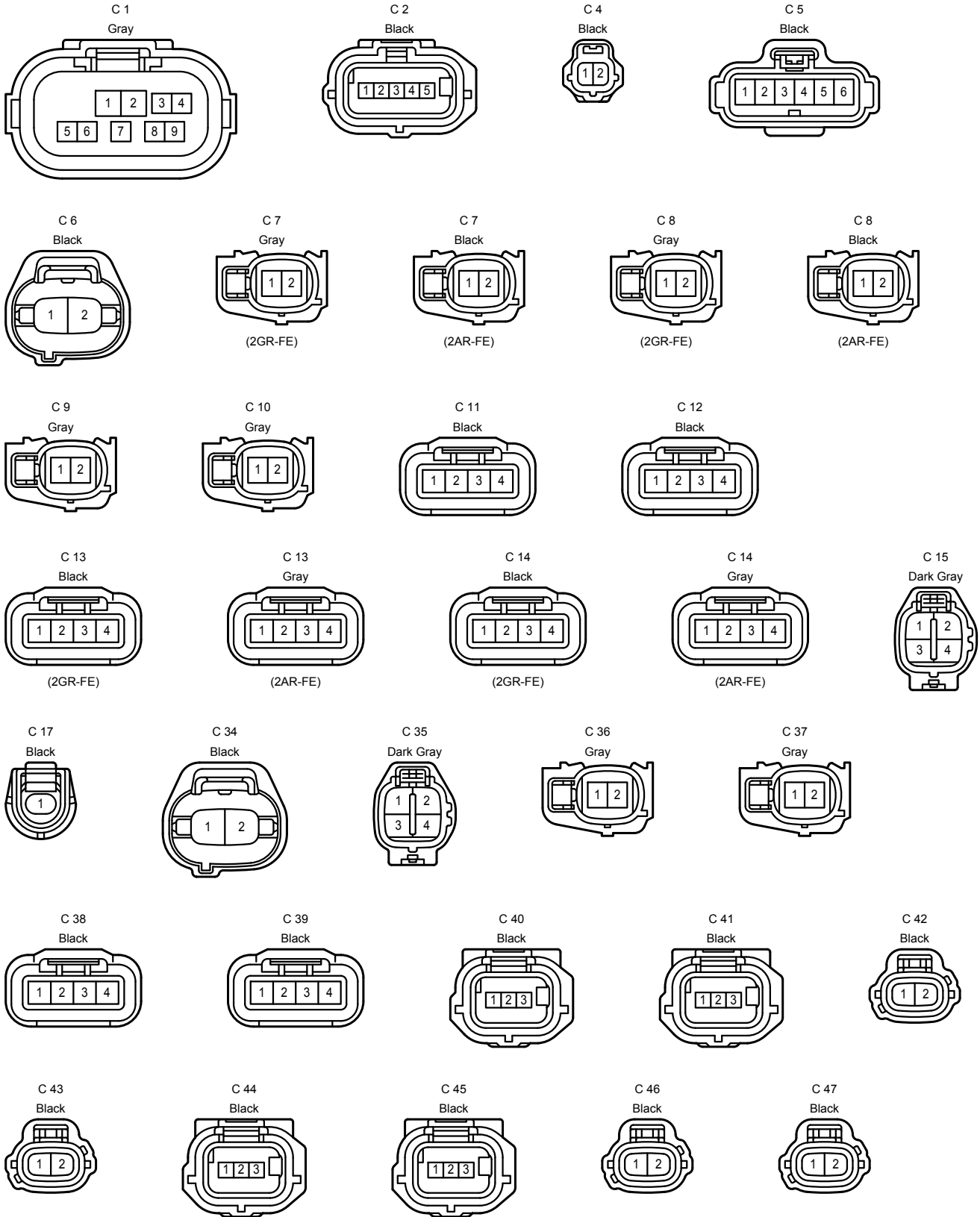

Engine Control <2GR-FE>

C 48

Gray



(2GR-FE)

C 50

Black

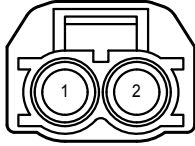

C 51

Black



C 52

Dark Gray



C 55

Black

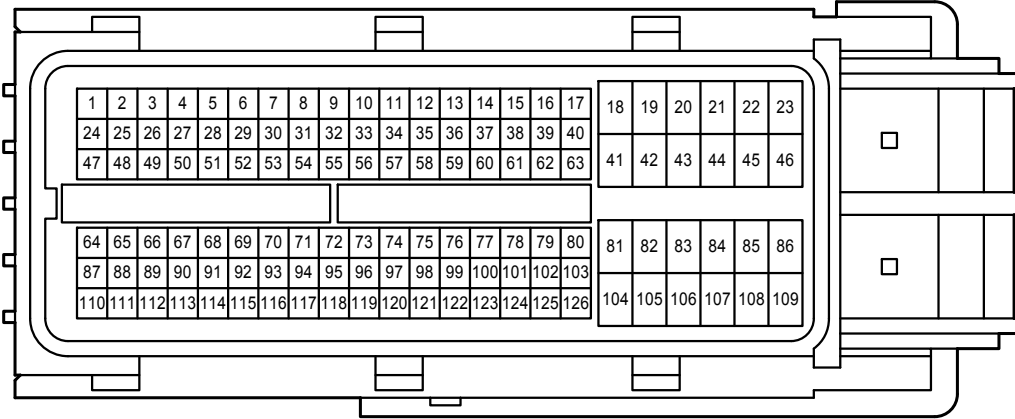

C 56

Gray

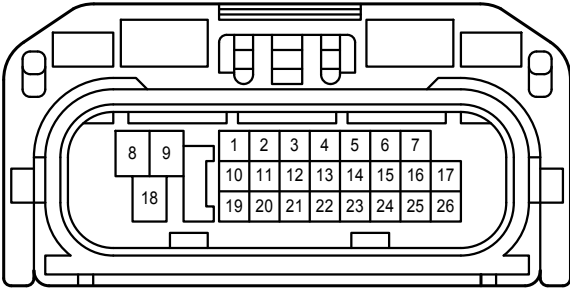

C 57

Gray

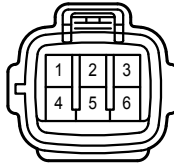

E 6

White

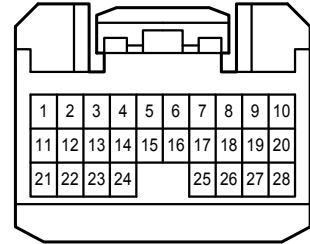

E 7

White

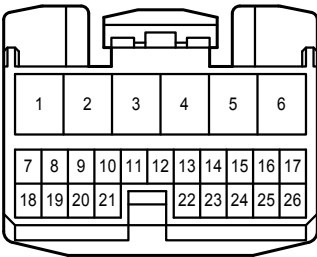

E 8

White

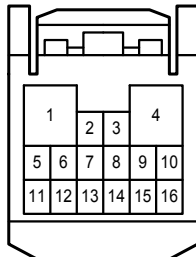

E 9

White

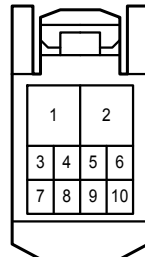

Engine Control <2GR-FE>

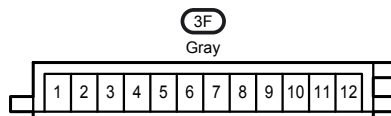
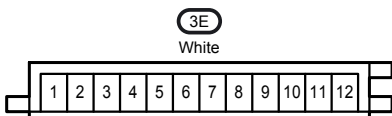
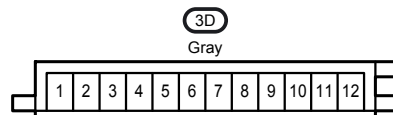
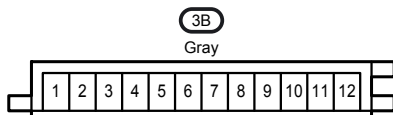
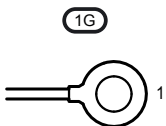
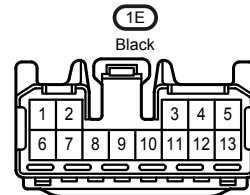
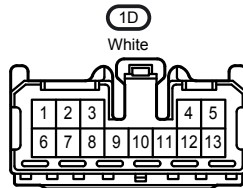
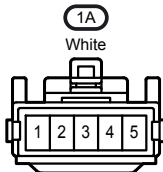
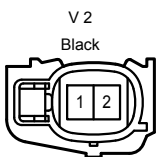
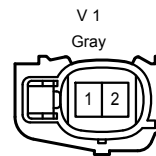
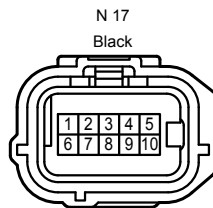
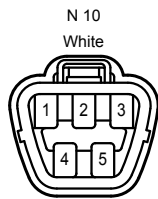
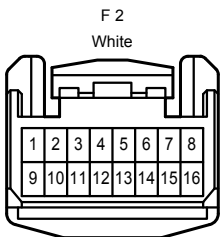
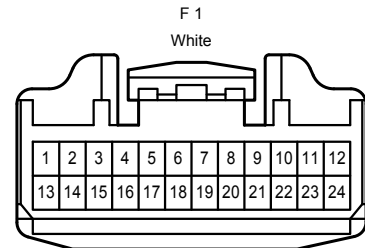
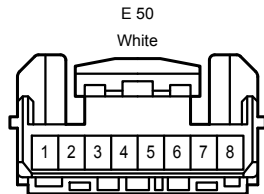
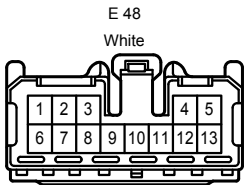
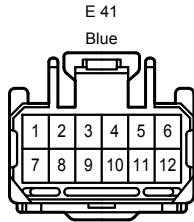
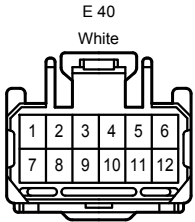
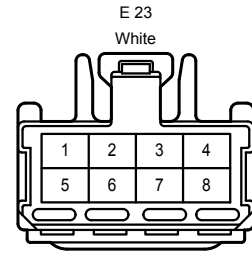
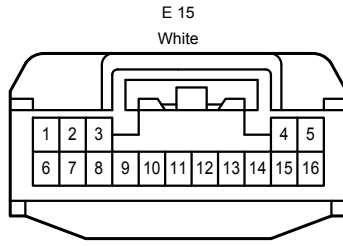
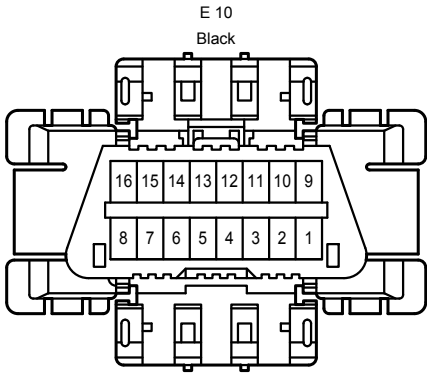

Engine Control <2GR-FE>

3G

White

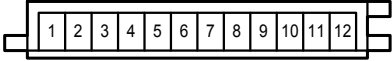

3H

Gray

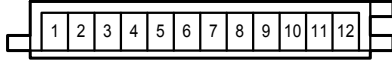

3L

Gray

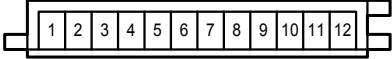

3P

White

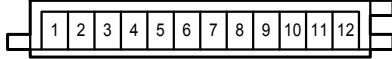

3Q

Gray

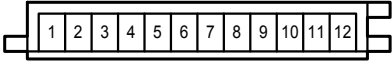

3U

White

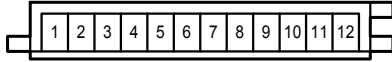

4A

White

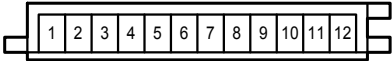

4C

White

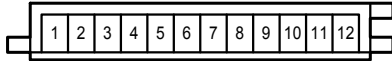

4E

White

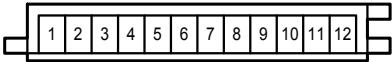

4F

Gray

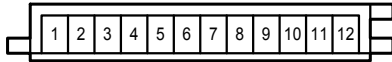

4G

White

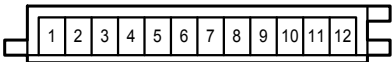

4K

White

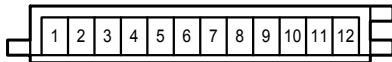

4L

Gray

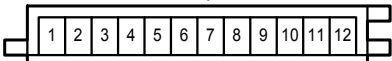

4M

White

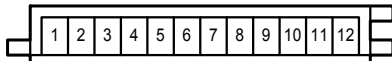

IC

White

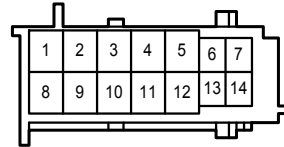

ID

White

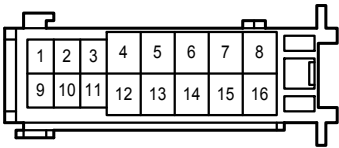

IF

White

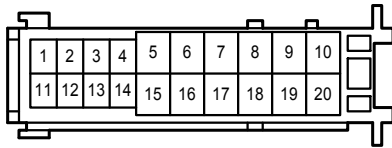

IG

White

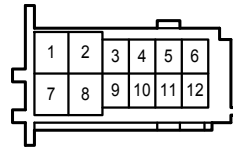

II

White

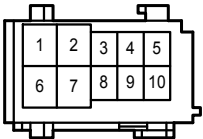

AE5

White

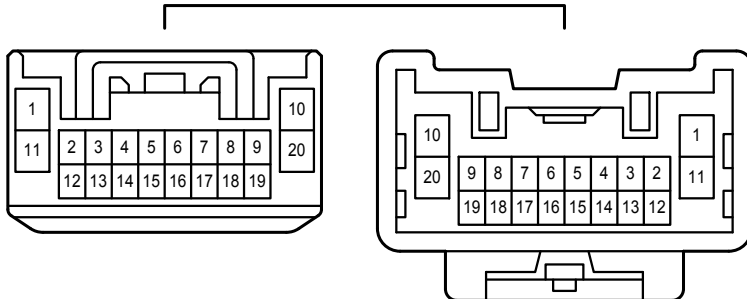

AE6
Gray

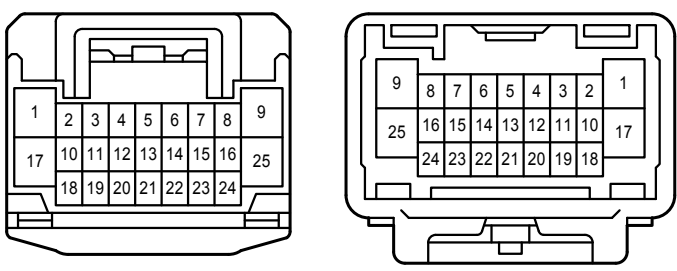

AE7
White

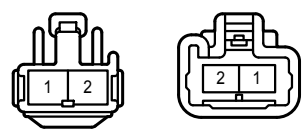

CA1
White

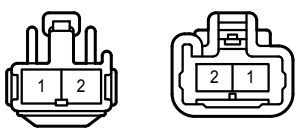

CA2

Black White

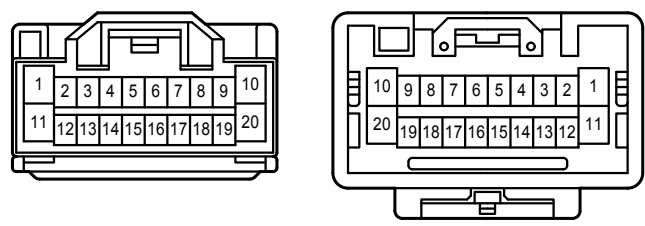

CA3
White

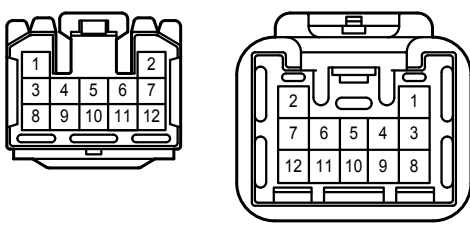

CV1
Gray

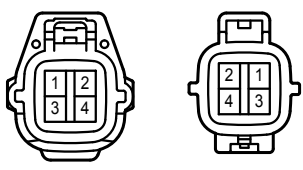

EA1
White

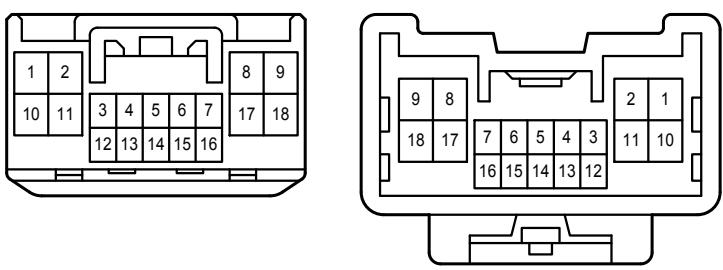

FE2
Blue

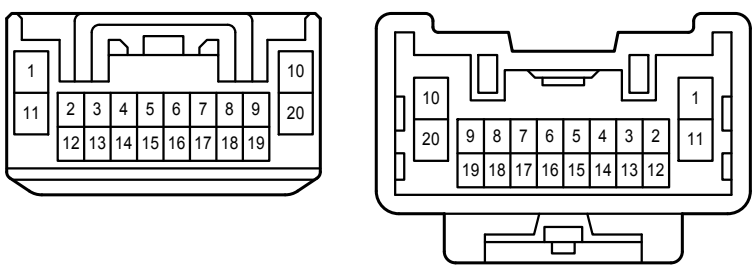

NA1
Black

